

=====

**TENDER DOCUMENT FOR**

**PROCUREMENT OF BALL VALVE FOR BI- DIRECTIONAL FLOW  
ARRANGEMENT IN COMPRESSOR STATION, BAIHATA**

**TENDER NO.: IGGL/GHY/C&P/PROJ/BALL-VALVE/04-26  
(E –TENDER NO: IGGL-100110)**

**DOMESTIC COMPETITIVE BIDDING THROUGH OPEN E-TENDERING**

**Issued by**

**INDRADHANUSH GAS GRID LIMITED (IGGL)  
(A Public Limited Company)**

**7<sup>th</sup> Floor, 122A, NRL Centre, Christian Basti, G S Road, Guwahati-781005, Assam**

**ATTENTION**

**THIS IS AN ELECTRONIC TENDER**

***For Participation in this tender please visit the web site: [Govt. CPP Portal - https://etenders.gov.in](https://etenders.gov.in).***

=====

## TABLE OF CONTENTS

<b>SL. No.</b>	<b>SECTION NO.</b>	<b>DESCRIPTION</b>
1.0	I	INVITATION FOR BID (IFB)
2.0	II	BID EVALUATION CRITERIA (BEC) AND EVALUATION METHODOLOGY
3.0	III	INSTRUCTIONS TO BIDDERS
4.0	IV	GENERAL CONDITIONS OF CONTRACT
5.0	V	FORMS & FORMATS
6.0	VI	SPECIAL CONDITIONS OF CONTRACT (SCC) & SCOPE OF SUPPLY (SOS)
7.0	VII	SCHEDULE OF RATES / PRICE SCHEDULE
8.0	VIII	ATTACHMENTS

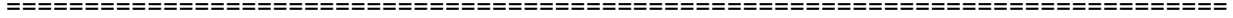

**SECTION-I**  
**INVITATION FOR BID (IFB)**

=====

**SECTION-I**

**"INVITATION FOR BID (IFB)"**

**Ref No: IGGL/GHY/C&P/PROJ/BALL-VALVE/04-26**

**Date: 10.04.2026**

To,  
Prospective Bidders

**SUB: PROCUREMENT OF BALL VALVE FOR BI-DIRECTIONAL FLOW ARRANGEMENT IN COMPRESSOR STATION, BAIHATA**

**Dear Sir/Madam,**

- 1.0 **INDRADHANUSH GAS GRID LIMITED (IGGL)**, a Joint Venture (JV) of IOCL, ONGC, GAIL, OIL and NRL, having its registered office at Guwahati in the State of Assam, invites Bids from bidders for the subject, in complete accordance with the following details and enclosed Tender Documents.
- 2.0 The brief details of the tender are as under:

<b>(A)</b>	<b>SCOPE OF SUPPLY / PROCUREMENT</b>	PROCUREMENT OF BALL VALVE FOR BI- DIRECTIONAL FLOW ARRANGEMENT IN COMPRESSOR STATION, BAIHATA
<b>(B)</b>	<b>TENDER NO. &amp; DATE</b>	IGGL/GHY/C&P/PROJ/BALL-VALVE/04-26 dated 10.04.2026 (E-Tender No. IGGL-100110)
<b>(C)</b>	<b>TYPE OF BIDDING SYSTEM</b>	TWO BID SYSTEM
<b>(D)</b>	<b>DELIVERY/CONTRACT PERIOD</b>	The materials are to be delivered within <b>32 (Thirty-Two) Weeks from</b> the dated of FOA or PO.
<b>(E)</b>	<b>BID SECURITY / EARNEST MONEY DEPOSIT (EMD)</b>	Applicable/Not Applicable  EMD amount of <b>Rs.1,00,410.00</b> to be submitted by the participating bidders.  <b>Note:</b> For MSEs and Start-Ups bidders, bid security declaration is required in place of the EMD amount. However, Traders / Dealers / Distributors / Stockiest / Wholesaler are not entitled for exemption of EMD.  Since tendered item are non-splitable or non- dividable, MSE quoting price within price band L1 (other than MSE) + 15%, will be awarded for full/ complete supply of total tendered value subject to matching of L1 price.
<b>(E1)</b>	<b>DECLARATION FOR BID SECURITY</b>	MSEs and Start-Ups (to whom exemption is allowed as per extant guidelines in vogue) are required to submit Declaration for Bid Security as per proforma at Form F-2A.
<b>(F)</b>	<b>AVAILABILITY OF TENDER DOCUMENT ON WEBSITE(S)</b>	From: <b>10.04.2026</b> to <b>01.05.2026</b> upto 14:00 Hrs, (IST) on following websites: IGGL Website – <a href="https://iggl.co.in/">https://iggl.co.in/</a> CPP Portal - <a href="https://etenders.gov.in">https://etenders.gov.in</a>
<b>(G)</b>	<b>DATE, TIME &amp; VENUE OF PRE-BID MEETING</b>	<b>Not Applicable.</b>

(H)	<b>DUE DATE &amp; TIME OF BID-SUBMISSION</b>	Date : <b>01.05.2026</b> Time : 14:00 HRS.
(I)	<b>DATE AND TIME OF UN-PRICED BID OPENING</b>	Date : <b>02.05.2026</b> Time : 14:00 HRS
(J)	<b>CONTACT DETAILS OF TENDER DEALING OFFICER</b>	1) Name: Mr. Kulajit Talukdar Designation: General Manager (C&P) Phone No.: 91-361-280-1400 E-mail: <a href="mailto:kulajit.talukdar@iggl.co.in">kulajit.talukdar@iggl.co.in</a>  2) Name: Mr. Tanveer Jalal Designation: Chief Manager (C&P) Phone No.: 91-361-280-1400 E-mail: <a href="mailto:tanveer.jalal@iggl.co.in">tanveer.jalal@iggl.co.in</a>  3) Name: Mr. Debashish Boruah Designation: Senior Officer (C&P) Phone No.: 91-361-280-1400 E-mail: <a href="mailto:debashish.boruah@iggl.co.in">debashish.boruah@iggl.co.in</a>
(K)	<b>DEALING IGGL'S OFFICE ADDRESS</b>	INDRADHANUSH GAS GRID LIMITED  7 <sup>th</sup> Floor, 122A, NRL Centre, Christian Basti, G S Road, Guwahati-781005, Assam
(L)	<b>TENDERED ITEM IS/ARE SPLITABLE / NON-SPLITABLE</b>	SPLITABLE / NON-SPLITABLE
(M)	<b>BONUS FOR EARLY COMPLETION</b>	<del>APPLICABLE</del> / NOT APPLICABLE
(N)	<b>Guarantee / Warranty/Defect Liability Period</b>	APPLICABLE / <del>NOT APPLICABLE</del> Twelve (12) months from the date of use of valve in pipeline (or) 24 months from the date of last shipment whichever period shall expire first.
(O)	<b>Applicability of provisions relating to MSE:</b>	APPLICABLE / <del>NOT APPLICABLE</del>
(P)	<b>Applicability of provisions relating to PPP-MII:</b>	APPLICABLE / <del>NOT APPLICABLE</del>
(Q)	<b>Bids from consortium/ joint venture:</b>	APPLICABLE / <del>NOT APPLICABLE</del>
(R)	<b>Applicability of provisions relating to Start-ups:</b>	APPLICABLE / <del>NOT APPLICABLE</del>

**Note: In case of the days specified above happens to be a holiday in IGGL, the next working day shall be implied.**

- =====
- 3.0 Bids must be submitted strictly in accordance with Clause No. 11 of ITB (Section-III). The IFB is an integral and inseparable part of the bidding document.
- 4.0 Bid must be submitted only on CPP Portal (<https://etenders.gov.in/eprocure/app>). Further, the following documents in addition to uploading in the bid on e-Portal shall also be submitted in Original (in physical form) within 7 (seven) days from the Bid Due Date provided the scanned copies of the same have been uploaded in e-tender Portal by the bidder along with e-bid within the Bid Due Date & Time, to the address mentioned in Bidding Data Sheet (BDS) [Annexure I to Section-III]:-
- (i) EMD/Bid Security /Declaration for Bid Security (As applicable)
  - (ii) Power of Attorney
  - ~~(iii) Line of Credit (if applicable)~~
  - ~~(iv) Integrity Pact.~~
- 5.0 Bidder(s) are advised to submit their bid strictly as per terms and conditions of the tender documents and not to stipulate any deviations/exceptions.
- 6.0 Any bidder, who meets the Bid Evaluation Criteria (BEC) and wishes to quote against this Tender Document, may download the complete Tender Document along with its amendment(s) if any from CPP portal and submit their Bid complete in all respect as per terms & conditions of Tender Document on or before the Bid Due Date & Time.
- 7.0 Bid(s) received from bidders to whom tender/information regarding this Tender Document has been issued as well as offers received from the bidder(s) by downloading Tender Document from CPP portal shall be taken into consideration for evaluation & award provided that the Bid is found responsive subject to provisions contained in Clause No. 1 of ITB (Section-III).  
The Tender Document calls for offers on single point "Sole Bidder" responsibility basis and in total compliance of Scope of Supply/Specifications as specified in Tender Document.
- 8.0 Any revision, clarification, addendum, corrigendum, time extension, etc. to this Tender Document will be hosted on the CPP portal only. Bidders are requested to visit the CPP portal regularly to keep themselves updated.
- 9.0 All the bidders including those who are not willing to submit their bid are required to submit F-6 (Acknowledgement cum Consent letter) duly filled within 7 days from receipt of tender information.

This is not an Order.

For & on behalf of  
Indradhanush Gas Grid Limited  
(Authorized Signatory)

Name : Kulajit Talukdar  
Designation : GM (C&P) & HoD  
E-mail ID : [kulajit.talukdar@iggl.co.in](mailto:kulajit.talukdar@iggl.co.in)  
Contact No. : 91-361-280-1400

=====

**CUT-OUT SLIP**

***DO NOT OPEN - THIS IS A QUOTATION***

**Tender Document No.** : IGGL/GHY/C&P/PROJ/BALL-VALVE/04-26 (E-TENDER NO. IGGL-100110)

**Description** : **PROCUREMENT OF BALL VALVE FOR BI- DIRECTIONAL FLOW ARRANGEMENT IN COMPRESSOR STATION, BAIHATA**

**Bid Due Date & Time** : **01.05.2026 at 14:00 hrs.**

**From:**

**To:**

..... .....	<b>GM (C&amp;P) &amp; HoD</b> <b>IGGL, 7th Floor, 122A, NRL Centre, Christian Basti, G S Road, Guwahati-781005, Assam</b> <b>PHONE: :9531101226/8</b>
----------------	---

***(To be pasted on the envelope containing Physical documents)***

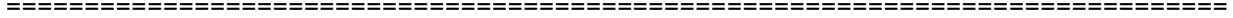

**SECTION-II**

**BID EVALUATION CRITERIA (BEC) & EVALUATION METHODOLOGY**

=====

## SECTION-II

### BID EVALUATION CRITERIA & EVALUATION METHODOLOGY

The intending bidders for above tender should meet the qualifications as given below:

#### **1.1 BEC (TECHNICAL):**

##### **Past Experience:**

- A.1 Bidder shall be a manufacturer of Ball valves as per API Specification 6D and shall have a valid license to use API monogram for the proposed manufacturing plant(s).

Note: Reference date for validity of API-6D license shall be considered as Bid due date for bid evaluation purpose.

- A.2 The Bidder shall have designed, manufactured, tested and supplied from the proposed manufacturing plant **at least one (1) number Ball valve** as per API 6D, identical in terms of design, and equal or higher in terms of size and pressure rating, as quoted for, in the last seven (7) years reckoned from the bid due date.

- A.3 Bids Submitted by The Owner / Authorized Supplier / Trading House / Sole Selling Agent / Distributor of A Manufacturer.

- A.3.1 Bids are invited from the Ball Valves manufacturer. In case an organization (the owner), who owns a separate manufacturing company can also submit the bid. Likewise, an authorized supplier / trading house / sole selling agent / distributor of a manufacturer can also submit the bid.

- A.3.2 Bid submitted by owner / authorized Supplier / Trading house / Sole Selling Agent / Distributor of a manufacturer shall also be considered provided the manufacturer meets the Technical Criteria stipulated under clause no. A.1 & A.2 above, subject to the following:

(a) Bidder is owner / authorized Supplier / Trading House / Sole Selling Agent / Distributor of the Manufacturer.

(b) The manufacturer as a policy does not quote directly and the manufacturer has to submit a declaration in this regard.

(c) Compliance of Technical Specifications and Guarantee/Warranty requirements by Manufacturer, in case order is placed on the bidder. Manufacturer has to submit declaration in this regard.

(d) One manufacturer can quote only through one marketing organization and a marketing Organization shall offer product of only one manufacturer.

#### **A5. DOCUMENTS TO BE SUBMITTED FOR COMPLIANCE TO TECHNICAL BEC:**

Documents/ Documentary Evidence required to be provided by the participating bidder along with the un-priced bid to qualify/ meet the requirements of BEC (technical):

- a.** Copy of Purchase order/ work order.

=====

b. Inspection release note/ completion certificate/ delivery proof/ invoice with payment proof linked with Purchase order/ work order.

c. The Bidders need to confirm that supplied materials are meeting Technical Specifications without any deviation. Bidders must submit all the details and documents about the proposed materials so that the acceptability of the materials in line with the technical specifications can be ascertained.

d. All Documentary evidence for qualification under A.1, A.2 or A.3 above

Note to A.1:

- i) A Job executed by a Bidder for its own plant/ project cannot be considered as experience for the purpose of meeting BEC of this Tender Document. However, jobs executed for Subsidiary/Fellow subsidiary / Holding company will be considered as experience for the purpose of meeting BEC subject to submission of tax paid invoice (s) duly certified by Statutory Auditor of the Bidder towards payments of statutory tax in support of the job executed for Subsidiary/Fellow subsidiary/ Holding company. Such Bidders to submit these documents in addition to the documents specified to meet BEC.
- ii) Consortium bids are not acceptable.

**1.2 BEC (FINANCIAL): Not Applicable.**

**1.3 Exchange rate for Conversion of Currency for evaluation of documents submitted by bidders for BEC which are in other currency than specified in BEC shall be as follows:**

- (a) **BEC (Technical Criteria):** Bill Selling (foreign exchange) Rate of State Bank of India as prevailing on the date of award of contract submitted by bidder.
- (b) In case, the SBI Selling rate is not available as on the date of conversion as specified above for respective cases, the exchange rate for conversion of currency shall be taken from the internet, such as:  
<https://www.xe.com/currencyconverter>  
<https://economictimes.indiatimes.com/markets/forex/currency-converter>  
<https://www.oanda.com/currency/converter>

**1.4** Only documents (Purchase Order, Completion certificate etc.) which have been referred/ specified in the bid shall be considered in reply to queries during evaluation of Bids.

After submission of bid, only related shortfall documents will be asked for in TQ/CQ and considered for evaluation. For example, if the bidder has submitted a contract without its completion/ performance certificate, the certificate will be asked for and considered. However, no new reference/ PO/WO/LOA is to be submitted by bidder in response to TQ/CQ so as to qualify and such documents will not be considered by IGGL for evaluation of Bid.

**1.5 RELAXATION OF PRIOR TURNOVER AND PRIOR EXPERIENCE FOR STARTUP (AS DEFINED IN GAZETTE NOTIFICATION NO. D.L-33004/99 DATED 18.02.2016 AND 23.05.2017 OF MINISTRY OF COMMERCE AND INDUSTRY), AS AMENDMED TIME TO TIME: Not Applicable.**

=====

**1.6 AUTHENTICATION OF DOCUMENTS SUBMITTED IN SUPPORT OF BID EVALUATION CRITERIA (BEC): Not Applicable.**

**1.7 ELIGIBILITY CRITERIA IN CASE BID IS SUBMITTED ON THE BASIS OF TECHNICAL EXPERIENCE OF FOREIGN BASED ANOTHER COMPANY (SUPPORTING COMPANY) WHICH HOLDS MORE THAN FIFTY PERCENT OF THE PAID-UP SHARE CAPITAL OF THE BIDDER COMPANY OR VICE VERSA:**

Offers of those bidders (not under consortium arrangement) who themselves do not meet the technical experience criteria as stipulated in the BEC and are quoting based on the experience of Foreign based another company (Supporting Company) can also be considered. In such case the supporting company should hold more than fifty percent of the paid-up share capital of the bidding company or vice versa.

However, the supporting company should on its own meet the technical experience as stipulated in the BEC and should not rely on any other company or through any other arrangement like Technical collaboration agreement.

In that case as the bidding company is dependent upon the technical experience of another company with a view to ensure commitment and involvement of the companies involved for successful execution of the contract, the participating bidder should enclose the following Agreements/Guarantees/ Undertakings along with the techno-commercial bid:

- (i) An Agreement (*as per format enclosed at Appendix- A1 to Section II*) between the bidder and the supporting company.
- (ii) Guarantee (*as per format enclosed at Appendix- A2 to Section II*) by the supporting company to IGGL for fulfilling the obligation under the Agreement along with certificate issued by Company Secretary as per *Appendix- A2A to Section II*.
- (iii) Undertaking by Supporting Company to provide a Performance Bank Guarantee (*as per format and instructions enclosed at Appendix- A3 to Section II*), equivalent to 50% of the value of the PBG which is to be submitted by the bidding company, in case of being the successful bidder.

In cases where foreign based supporting company does not have Permanent Establishment in India as per Indian Income Tax Act, the bidding company can furnish Performance Bank Guarantee for an amount which is sum of PBG amount to be submitted by the bidder and additional PBG amount required to be submitted by the supporting company subject to the condition that supporting company have 100% paid up equity share capital of the bidder either directly or through intermediate subsidiaries or vice versa.

In such case bidding company shall furnish an undertaking that their foreign based supporting company is not having any Permanent Establishment in India in terms of Income Tax Act of India.

- (iv) Undertaking from the supporting company to the effect that in addition to invoking the PBG submitted by the bidding company, the PBG provided by supporting company shall be invoked by IGGL due to non-performance of the bidding company.

**Note:**

- 1.0 In case Supporting Company fails to submit Bank Guarantee as per (iii) above, EMD/SD submitted by the bidder shall be forfeited.

2.0 The Financial BEC of tender is to be met by bidder on their own.

3.0 The Supporting Company shall meet conditions of 'Eligible Bidder', as per clause no. 2 of Section-III (ITB).

4.0 The clause 2.9 as below shall be applicable to above supporting company also.

**1.8** Apart from above, Bidder must submit all other relevant documents/ information as specified in the Scope of Supply / SCC for Technical Evaluation of bid or specified elsewhere in the Tender Document, towards proof of its responsiveness.

**1.9** Experience of a bidder acquired as a subcontractor can be accepted against submission of certificate from end user by such bidder along with other specified documents

**1.10 PROCUREMENT FROM A BIDDER WHICH SHARES A LAND BORDER WITH INDIA**

**1.** OM no. 7/10/2021-PPD (1) dated 23.02.2023, Department of Expenditure, Ministry of Finance, Govt. of India refers. The same are available at website <https://doe.gov.in/procurement-policy-divisions>.

**2.** Any bidder from a country which shares a land border with India will be eligible to bid in this tender only if the bidder is registered with the Competent Authority. For details of competent authority refer to Annexure I of Order (Public Procurement no. 4) dated 23.02.2023.

Further, any bidder (including bidder from India) having specified Transfer of Technology (ToT) arrangement with an entity from a country which shares a land border with India, shall also require to be registered with the same competent authority.

Further the above will not apply to bidders from those countries (even if sharing a land border with India) to which the Government of India has extended lines of credit or in which the Government of India is engaged in development projects. Updated lists of countries to which lines of credit have been extended or in which development projects are undertaken are given in the website of the Ministry of External Affairs, Govt. of India.

**3. "Bidder"** (including the term 'tenderer', 'consultant' 'vendor' or 'service provider' in certain contexts) **for purpose of this provision** means any person or firm or company, including any member of a consortium or joint venture (that is an association of several persons, or firms or companies), every artificial juridical person not falling in any of the descriptions of bidders stated hereinbefore, including any agency, branch or office controlled by such person, participating in a procurement process.

**4. "Bidder from a country which shares a land border with India"** for the purpose of this:

- a. An entity incorporated, established or registered in such a country; or
- b. A subsidiary of an entity incorporated, established or registered in such a country; or
- c. An entity substantially controlled through entities incorporated, established or registered in such a country; or
- d. An entity whose beneficial owner is situated in such a country; or
- e. An Indian (or other) agent of such an entity; or
- f. A natural person who is a citizen of such a country; or
- g. A consortium or joint venture where any member of the consortium or joint venture falls under any of the above

=====

**5. "Beneficial owner"** for the purpose of above (4) will be as under:

- i. In case of a company or Limited Liability Partnership, the beneficial owner is the natural person(s), who, whether acting alone or together, or through one or more juridical person(s), has a controlling ownership interest or who exercises control through other means.

Explanation—

- a) "Controlling ownership interest" means ownership of, or entitlement to, more than twenty-five per cent of shares or capital or profits of the company;
- b) "Control" shall include the right to appoint the majority of the directors or to control the management or policy decisions, including by virtue of their shareholding or management rights or shareholders agreements or voting agreements;
- ii) In case of a partnership firm, the beneficial owner is the natural person(s) who, whether acting alone or together, or through one or more juridical person, has ownership of entitlement to more than fifteen percent of capital or profits of the partnership;
- iii) In case of an unincorporated association or body of individuals, the beneficial owner is the natural person(s), who, whether acting alone or together, or through one or more juridical person, has ownership of or entitlement to more than fifteen percent of the property or capital or profits of such association or body of individuals;
- iv) Where no natural person is identified under (i) or (ii) or (iii) above, the beneficial owner is the relevant natural person who holds the position of senior managing official;
- v) In case of a trust, the identification of beneficial owner(s) shall include identification of the author of the trust, the trustee, the beneficiaries with fifteen percent or more interest in the trust and any other natural person exercising ultimate effective control over the trust through a chain of control or ownership.

**6. "Agent"** for the purpose of this Order is a person employed to do any act for another, or to represent another in dealings with third persons.

Note:

- (i) A person who procures and supplies finished goods from an entity from a country which shares a land border with India will, regardless of the nature of his legal or commercial relationship with the producer of the goods, be deemed to be an Agent for the purpose of this Order.
- (ii) However, a bidder who only procures raw material, components etc. from an entity from a country which shares a land border with India and then manufactures or converts them into other goods will not be treated as an Agent.]

**7. "Transfer of Technology"** means dissemination and transfer of all forms of commercially usable knowledge such as transfer of know-how, skills, technical expertise, designs, processes and procedures, trade secrets, which enables the acquirer of such technology to perform activities using the transferred technology independently. (Matters of interpretation of this term shall be referred to the Registration Committee constituted by the Department for Promotion of Industry and Internal Trade, and the interpretation of the Committee shall be final).

=====

**8. "Specified Transfer of Technology"** means a transfer of technology in the sectors and/ or technologies specified at Schedule-I, II & 3 of this order.

**9. SUBMISSION OF CERTIFICATE IN BIDS:**

Bidder shall submit a certificate in this regard as Form-I-A.

For cases falling under the category of Transfer of Technology, Bidder shall submit a certificate in this regard as Form-I-B.

If such certificate given by a bidder whose bid is accepted is found to be false, this would be a ground for immediate rejection of the bid/termination and further action as per "Procedure for Action in case of Corrupt/Fraudulent/ Collusive / Coercive Practices" of tender document.

**10.** The registration, wherever applicable, should be valid at the time of submission of bids and at the time of acceptance of bids. In respect of supply otherwise than by tender, registration should be valid at the time of placement of order. If the bidder was validly registered at the time of acceptance / placement of order, registration shall not be a relevant consideration during contract execution.

**11. PROVISION TO BE IN WORKS CONTRACTS, INCLUDING TURNKEY CONTRACTS:**

The successful bidder shall not be allowed to sub-contract works to any contractor from a country which shares a land border with India unless such contractor is registered with the Competent Authority. The definition of "contractor from a country which shares a land border with India" shall be as in Para 4 herein above. A Certificate to this regard is to be submitted by bidder is placed at Form-II

**1.11 BID EVALUATION METHODOLOGY:** The evaluation shall be carried out as per the following methodology:

- i)** The priced bids of techno-commercially acceptable bidders shall be opened and considered for further evaluation.
- ii)** Bidder to quote for the item as per SOR. The evaluation shall be done on overall basis (i.e., L1 position shall be found out on overall lowest FOT Site Cost basis) and complete order shall be placed on a single agency.
- iii)** The evaluation of all techno-commercially-acceptable bids, to arrive at the lowest-evaluated bid, shall be carried out on Total Quoted Price by the bidder (including packing forwarding charges, freight charges, transit insurance, TPI & GST) for entire scope of work, after arithmetic check. Accordingly, order will be awarded to lowest bidder on lowest cost basis.
- iv)** In case of Tie at L1 position following criteria shall be followed:
  - In case one of the L1 bidders is MSE owned by SC/ST or a women Entrepreneur, then order shall be placed on such bidder.
  - If one of the L1 bidders is MSE, then an order shall be placed on such bidders.
  - Otherwise, the order shall be placed on the L1 bidder having a higher turnover in the previous financial year. In case there is a tie at the lowest bid (L-1) position between only startup bidders and none of them has past turnover, the order will be placed on the startup that was registered earlier with the Department of Industrial Promotion and Policy.

**UNDERTAKING ON LETTERHEAD**

To,  
M/s Indradhanush Gas Grid Limited (IGGL)

**SUB: PROCUREMENT OF BALL VALVE FOR BI- DIRECTIONAL FLOW ARRANGEMENT IN COMPRESSOR STATION, BAIHATA**

TENDER NO: **IGGL/GHY/C&P/PROJ/BALL-VALVE/04-26**

Dear Sir

We have read the clause regarding Provisions for Procurement from a Bidder which shares a land border with India, we certify that, bidder M/s \_\_\_\_\_ (***Name of Bidder***) is:

- (i) Not from such a country [       ]
- (ii) If from such a country, has been registered with the Competent Authority. [       ]  
(Evidence of valid registration by the Competent Authority shall be attached)

***(Bidder is to tick appropriate option (✓) above).***

We hereby certify that bidder M/s \_\_\_\_\_ (***Name of Bidder***) fulfils all requirements in this regard and is eligible to be considered against the tender.

Place: [Signature of Authorized Signatory of Bidder]  
Date: Name:  
Designation:  
Seal:

**UNDERTAKING ON LETTERHEAD**

***(Applicable in case of Transfer of Technology cases only)***

To,  
M/s Indradhanush Gas Grid Limited (IGGL)

**SUB: PROCUREMENT OF BALL VALVE FOR BI- DIRECTIONAL FLOW ARRANGEMENT IN COMPRESSOR STATION, BAIHATA**

TENDER NO: **IGGL/GHY/C&P/PROJ/BALL-VALVE/04-26**

Dear Sir

We have read the clause regarding Provisions for Procurement from a Bidder having Transfer of Technology (ToT) arrangement which shares a land border with India, we certify that, bidder M/s \_\_\_\_\_ ***(Name of Bidder)*** is:

- (i) Does not have ToT with such a country [       ]
- (ii) If having ToT from such a country, has been registered [       ]  
with the Competent Authority.  
(Evidence of valid registration by the  
Competent Authority shall be attached)

***(Bidder is to tick appropriate option (✓) above).***

We hereby certify that bidder M/s \_\_\_\_\_ ***(Name of Bidder)*** fulfils all requirements in this regard and is eligible to be considered against the tender.

Place: [Signature of Authorized Signatory of Bidder]  
Date: Name:  
Designation:  
Seal:

=====

## Schedule-I

List of Category-I Sensitive Sectors:

Sr. No.	Sector
(i)	Atomic Energy
(ii)	Broadcasting/ Print and Digital Media
(iii)	Defence
(iv)	Space
(v)	Telecommunications

## Schedule-II

List of Category-II Sensitive Sectors:

Sr. No.	Sector
(i)	Power and Energy (including exploration/ generation/ transmission/ distribution/ pipeline)
(ii)	Banking and Finance including Insurance
(iii)	Civil Aviation
(iv)	Construction of ports and dams & river valley projects
(v)	Electronics and Microelectronics
(vi)	Meteorology and Ocean Observation
(vii)	Mining and extraction (including deep sea projects)
(viii)	Railways
(ix)	Pharmaceuticals & Medical Devices
(x)	Agriculture
(xi)	Health
(xii)	Urban transportation

## Schedule-III

List of Sensitive Technologies

Sr. No.	Sensitive Technologies
(i)	Additive Manufacturing (e.g. 3D Printing)
(ii)	Any equipment having electronic programmable components or autonomous systems (e.g. SCADA systems)
(iii)	Any technology used for uploading and streaming of data including broadcasting, satellite communication etc.
(iv)	Chemical Technologies
(v)	Biotechnologies including Genetic Engineering and Biological Technologies
(vi)	Information and Communication Technologies
(vii)	Software

=====
**Appendix-A1 to Section II**

**FORMAT OF AGREEMENT TO BE EXECUTED BETWEEN BIDDER AND THEIR FOREIGN BASED SUPPORTING COMPANY ON INDIAN NON-JUDICIAL STAMP PAPER OF REQUISITE VALUE DULY NOTARIZED.**

This agreement made this \_\_\_ day of \_\_\_ month \_\_\_ year by and between M/s. \_\_\_\_\_ (Fill in Bidder’s full name, constitution and registered office address) \_\_\_\_\_ hereinafter referred to as bidder on the first part and M/s. \_\_\_\_\_ (Fill in full name, constitution and registered office address company which hold more than fifty percent of the paid up share capital of the bidding company or vice versa) hereinafter referred to as “Supporting Company” of the second part.

Whereas

M/s. Indradhanush Gas Grid Limited (hereinafter referred to as IGGL) has invited offers vide their tender No. \_\_\_\_\_ for \_\_\_\_\_ and M/s. \_\_\_\_\_ (Bidder) intends to bid against the said tender and desires to have technical support of M/s. \_\_\_\_\_ [Supporting Company]

And whereas Supporting Company represents that they have gone through and understood the requirements of the subject tender and are capable and committed to provide the services as required by the bidder for successful execution of the contract, if awarded to the bidder.

Now, it is hereby agreed to by and between the parties as follows:

- a) M/s. \_\_\_\_\_ (Bidder) will submit an offer to IGGL for the full scope of work as envisaged in the tender document as a main bidder and liaise IGGL directly for any clarifications etc. in this context.
- b) M/s. \_\_\_\_\_ [Supporting Company] undertakes to provide technical support and expertise, expert manpower and project management including financial support, if so required, to the bidder to discharge its obligations as per the Scope of Work of the tender / Contract for which offer has been made by the bidder and accepted the IGGL.
- c) The Bidder/ Supporting Company holds more than 50% paid up equity capital of the Supporting Company/ Bidder.
- d) This agreement will remain valid till validity of bidder's offer to IGGL including extension if any and till satisfactory performance of the contract, the same is awarded by IGGL to the bidder.
- e) Supporting Company undertakes that this agreement shall remain enforceable even if their stake in Bidder is diminished during the execution of works under the contract between the Bidder and IGGL.
- f) The bidder shall have the overall responsibility of satisfactory execution of the contract awarded by IGGL, however without prejudice to any rights that IGGL might have against the Supporting Company.
- g) It is further agreed that, if contract pursuant to Supporting Company shall be jointly and severally responsible to IGGL for the performance of works during contract period and for the satisfactory execution of the contract, and for all the consequences for non-performance thereof.

In witness whereof the parties hereto have executed this agreement on the date mentioned above.

For and on behalf of  
(Bidder)

For and on behalf of  
(Supporting Company)

M/s.  
Witness:  
1)  
2)

M/s.  
Witness:  
1)  
2)

=====

**Appendix-A2 to Section II**

**GUARANTEE BY THE FOREIGN BASED SUPPORTING COMPANY/ GUARANTOR**  
**(to be executed on plain paper)**

THIS DEED OF GUARANTEE executed at ..... this ..... day of ..... by M/s ..... (mention complete name) a company duly established and existing under the laws of ..... (insert country), having its Registered Office at ..... hereinafter called "the Guarantor and/ or the Supporting Company" which expression shall, unless excluded by or repugnant to the subject or context thereof, be deemed to include its successors and permitted assignees.

FOR

M/s ..... (bidder) a company duly established and existing under the laws of ..... (insert country), having its Registered Office at ..... hereinafter called the "Bidder" which expression shall, unless excluded by or repugnant to the subject or context thereof, be deemed to include its successors and permitted assignees.

TOWARDS

M/s Indradhanush Gas Grid Limited, a company duly registered under the law of India having its Registered Office at 7th Floor, 122A, NRL Centre, Christian Basti, G S Road, Guwahati, Assam-781005, India, and having Purchase centre at the same place hereinafter called "IGGL" which expression shall unless excluded by or repugnant to the context thereof, be deemed to include its successor and assignees

WHEREAS IGGL has invited tender number ..... for ..... on ..... and the bidder has submitted it bid number..... in response to the above mentioned tender invited by IGGL.

AND WHEREAS the bidder/ Guarantor Company holds more than 50% paid up equity capital of the Supporting Company/ Bidder.

AND WHEREAS one of the condition for acceptance of Bidder's bid against said tender is that in case the bidder is seeking to qualify upon the technical credentials of its Guarantor Company, then the bidder shall arrange a guarantee from its Guarantor Company guaranteeing due and satisfactory performance of the work covered under the said tender including any change therein as may be deemed appropriate by the IGGL at any stage.

The Guarantor represents that they have gone through and understood the requirement of the above said tender and are capable of and committed to provide technical and such other supports as may be required by the Bidder for successful execution of the same.

The Bidder and the Guarantor have entered into an agreement dated ..... as per which the Guarantor shall be providing technical, financial and such other supports as may be necessary for performance of the work under the tender, if the contract is awarded to the Bidder.

Accordingly, at the request of the Bidder and in consideration of and as a requirement for the IGGL to enter into agreement(s) with the Bidder, the Guarantor hereby guarantees and undertakes that upon award of Contract to Bidder against bid number ....., made by the Bidder under tender number.....:

- =====
1. The Guarantor unconditionally agrees that in case of non-performance by the Bidder of any of its obligations in any respect, the Guarantor shall, immediately on receipt of notice of demand by the IGGL, take up the job without any demur or objection, in continuation and without loss of time and without any cost to the IGGL and duly perform the obligations of the Bidder to the satisfaction of the IGGL.
  2. The Guarantor agrees that the Guarantee contained herein shall remain valid till the satisfactory execution and completion of the work (including discharge of the warranty obligations) awarded to the Bidder.
  3. The Guarantor shall be jointly and severally responsible to IGGL for satisfactory performance of works during contract period and for the satisfactory execution of the contract, and for all consequences for non-performance thereof.
  4. The liability of the Guarantor, under the Guarantee, is limited of the Bidder for non-performance under the contract entered between IGGL and the Bidder. This will, however, be in addition to the forfeiture of the Performance and Advance Guarantees furnished by the Bidder.
  5. The Guarantor agrees to execute a Corporate Guarantee in favour of IGGL, guaranteeing the performance of obligations by the Bidder, in case the Contract is awarded to the Bidder by IGGL.
  6. The Guarantor represents that this Guarantee has been issued after due observance of the appropriate laws in force in India. The Guarantor hereby undertakes that the Guarantor shall obtain and maintain in full force and effect all the governmental and other approvals and consents that are necessary and do all other acts and things necessary or desirable in connection therewith or for the due performance of the Guarantor's obligations towards IGGL.
  7. Any dispute arising out of or in connection with this contract, including any question regarding its existence, validity or termination, shall be referred to and finally resolved by arbitration. It is further agreed that Claims by and against the Guarantor, the Bidder and IGGL under the different contract to be entered pursuant to their relationship can be brought under a single reference and there shall be no bar on the consolidation of such proceedings before the same arbitral tribunal. The governing law shall be the laws of India and seat of arbitration shall be Guwahati, Assam, India. The language of arbitration shall be English.
  8. The Guarantor hereby declares and represents that this Guarantee has been given without any undue influence or coercion, and that the Guarantor has fully understood the implications of the same.
  9. In case of award of contract to the bidder, the Guarantor shall provide Performance Bank Security to IGGL, equivalent to 50% of the value of Performance Bank Security to be submitted by the bidding company, in the prescribed format within 15 days from the date of Fax of Acceptance, as guarantee for performance by the bidder/Supplier. The Guarantor hereby expressly agrees that if in the opinion of IGGL, the Bidder / Supplier has failed to perform its obligations under the contract in any manner, IGGL shall have unfettered right to invoke the said Bank guarantee. The guarantor hereby agrees that decision of IGGL about performance of the bidder/Supplier shall be final and shall not be questioned by the Guarantor. Guarantor shall have no objection to invocation of the Performance Bank Guarantee submitted by the Guarantor

OR

(applicable, subject to meeting the conditions stipulated in BEC in respect of additional Performance Bank Security)



=====

In case of award of contract to the bidder, the bidder on behalf of the Guarantor shall provide additional Performance Bank Security to IGGL, equivalent to 50% of the value of Performance bank Security to be submitted by the bidding company, in the prescribed format within 15 days from the date of Fax of Acceptance, as guarantee for performance by the bidder/Supplier. The Guarantor hereby expressly agrees that if in the opinion of IGGL, the Bidder / Supplier has failed to perform its obligations under the contract in any manner, IGGL shall have unfettered right to invoke the said Bank guarantee. The Guarantor hereby agrees that decision of IGGL about performance of the bidder / Supplier shall be final and shall not be questioned by the Guarantor. Guarantor shall have no objection to invocation of the Performance Bank Security submitted by the Bidder on behalf The Guarantor represents and confirms that the Guarantor has the legal capacity, power and authority to issue this Guarantee and that giving of this Guarantee and the performance, and observations of the obligations hereunder do not contravene any existing laws.

(Strike through the clause whichever is not applicable)

- 10. The Guarantor represents and confirms that the Guarantor has the legal capacity, power and authority to issue this Guarantee and that giving of this Guarantee and the performance and observations of the obligations hereunder do not contravene any existing laws.

For & on behalf of (Supporting Company)

M/s \_\_\_\_\_

Signature\_\_\_\_\_

Name\_\_\_\_\_

Designation \_\_\_\_\_

official seal\_\_\_\_\_

Witness:

1.Signature\_\_\_\_\_

Full Name \_\_\_\_\_

Address\_\_\_\_\_

2.Signature\_\_\_\_\_

Full Name \_\_\_\_\_

Address\_\_\_\_\_

**INSTRUCTIONS FOR FURNISHING GUARANTEE**

- 1. The official(s) executing the guarantee should affix full signature(s) on each page.
- 2. Resolution passed by Board of Directors of the guarantor company authorizing the signatory(ies) to execute the guarantee, duly certified by Company Secretary should be furnished along with Guarantee

=====

## Appendix-A2A to Section II

### **CERTIFICATE ISSUED BY COMPANY SECRETARY OF THE GUARANTOR COMPANY**

“Obligations contained in deed of guarantee No. \_\_\_\_\_ furnished against tender No. \_\_\_\_\_ are enforceable against the Guarantor Company and the same do not, in any way, contravene any law of the country of which the Guarantor Company is the subject.”

The above certificate should be enclosed along with the Guarantee.

=====

**Appendix-A3 to Section II**

**PROFORMA OF "BANK GUARANTEE" TOWARDS PERFORMANCE SECURITY / SECURITY DEPOSIT BY  
FOREIGN BASED SUPPORTING COMPANY OF THE BIDDING COMPANY  
CONTRACT PERFORMANCE SECURITY /SECURITY DEPOSIT  
(ON NON-JUDICIAL STAMP PAPER OF APPROPRIATE VALUE)**

To,

To, Indradhanush Gas Grid Limited  _____	<b>Bank Guarantee No.</b>	
	<b>Date of BG</b>	
	<b>BG Valid up to (Expiry date)</b>	
	<b>Claim period up to (indicate date of expiry of claim period which includes minimum three months from the expiry date)</b>	
	<b>Stamp Sl. No./e-Stamp Certificate No.</b>	

**Dear Sir(s),**

M/s. \_\_\_\_\_ having registered office at \_\_\_\_\_ (herein after called the "SUPPLIER" which expression shall wherever the context so require include its successors and assignees) have been placed/ awarded the job/work of \_\_\_\_\_ vide PO/LOA/FOA No. \_\_\_\_\_ dated \_\_\_\_\_ (herein after called CONTRACT) for Indradhanush Gas Grid Limited having registered office at 7<sup>TH</sup> Floor, 122A, NRL Centre, Christian Basti, G S Road, Guwahati, Assam-781005 (herein after called the "IGGL" which expression shall wherever the context so require include its successors and assignees).

Further, M/s \_\_\_\_\_ (Name of the Supporting company) having its registered/head office at \_\_\_\_\_ based on whose experience/technical strength, the SUPPLIER has qualified for award of contract (hereinafter referred to as the 'SUPPORTING COMPANY') which expression shall, unless repugnant to the context or meaning thereof include all its successors, administrators, executors and assignees) has agreed to provide complete technical and other support to the SUPPLIER for successful completion of the contract as mentioned above, entered between IGGL and the SUPPLIER and IGGL having agreed that the 'SUPPORTING COMPANY' shall furnish to IGGL a performance guarantee for Indian Rupees/US\$ ..... towards providing complete financial and other support to the SUPPLIER for successful completion of the contract as mentioned above,

1. The said M/s. \_\_\_\_\_ (Supporting Company) has approached us and at their request and in consideration of the premises we having our office at \_\_\_\_\_ have agreed to give such guarantee as hereinafter mentioned.
2. We (name of the bank) \_\_\_\_\_ registered under the laws of \_\_\_\_\_ having head/registered office at \_\_\_\_\_ (hereinafter referred to as "the Bank", which expression shall, unless repugnant to the context or meaning thereof, include all its successors, administrators, executors and permitted assignees) do hereby guarantee and undertake to pay immediately on first demand in writing any/all moneys to the extent of Indian Rs./US\$ (in figures) \_\_\_\_\_ (Indian Rupees/US Dollars (in words) \_\_\_\_\_) without any demur, reservation, contest or protest and/or without any reference to the 'SUPPORTING COMPANY'. Any such demand made by IGGL on the Bank by serving a written notice shall be conclusive and binding, without any proof, on the bank as regards

=====

the amount due and payable, notwithstanding any dispute(s) pending before any Court, Tribunal, Arbitrator or any other authority and/or any other matter or thing whatsoever, as liability under these presents being absolute and unequivocal. We agree that the guarantee herein contained shall be irrevocable and shall continue to be enforceable until it is discharged by IGGL in writing. This guarantee shall not be determined, discharged or affected by the liquidation, winding up, dissolution or insolvency of the 'SUPPORTING COMPANY' and shall remain valid, binding and operative against the bank.

3. The Bank also agrees that IGGL at its option shall be entitled to enforce this Guarantee against the Bank as a principal debtor, in the first instance, without proceeding against the 'SUPPORTING COMPANY' and notwithstanding any security or other guarantee that IGGL may have in relation to the 'SUPPORTING COMPANY's liabilities.
4. The Bank further agrees that IGGL shall have the fullest liberty without our consent and without affecting in any manner our obligations hereunder to vary any of the terms and conditions of the said CONTRACT or to extend time of performance by the said SUPPLIER from time to time or to postpone for any time or from time to time exercise of any of the powers vested in IGGL against the said SUPPLIER/ and to forbear or enforce any of the terms and conditions relating to the said agreement and we shall not be relieved from our liability by reason of any such variation, or extension being granted to the said SUPPLIER or for any forbearance, act or omission on the part of IGGL or any indulgence by IGGL to the said SUPPLIER(s) or any such matter or thing whatsoever which under the law relating to sureties would, but for this provision, have effect of so relieving us.
5. The Bank further agrees that the Guarantee herein contained shall remain in full force during the period that is taken for the performance of the CONTRACT and all dues of IGGL under or by virtue of this CONTRACT have been fully paid and its claim satisfied or discharged or till IGGL discharges this guarantee in writing, whichever is earlier.
6. This Guarantee shall not be discharged by any change in our constitution, in the constitution of IGGL or that of the 'SUPPORTING COMPANY'.
7. The Bank confirms that this guarantee has been issued with observance of appropriate laws of the country of issue.
8. The Bank also agrees that this guarantee shall be governed and construed in accordance with Indian Laws and subject to the exclusive jurisdiction of Indian Courts of the place from where the purchase CONTRACT has been placed.
9. Notwithstanding anything contained hereinabove, our liability under this Guarantee is limited to Indian Rs. / US\$ (in figures) \_\_\_\_\_ (Indian Rupees/US Dollars (in words) \_\_\_\_\_ only) and our guarantee shall remain in force until (indicate the date of expiry of bank guarantee) \_\_\_\_\_.
10. We have power to issue this guarantee in your favor under Memorandum and Articles of Association and the undersigned has full power to do under the Power of Attorney, dated \_\_\_\_\_ granted to him by the Bank.
11. Notwithstanding anything contained herein:
  - a) The Bank's liability under this Guarantee shall not exceed (currency in figures) ..... (currency in words only) .....

- =====
- b) This Guarantee shall remain in force upto \_\_\_\_\_ (this date should be expiry date of defect liability period of the Contract) and any extension(s) thereof; and
  - c) The Bank shall be released and discharged from all liability under this Guarantee unless a written claim or demand is issued to the Bank on or before the midnight of .....(indicate date of expiry of claim period which includes minimum three months from the expiry of this Bank Guarantee) and if extended, the date of expiry of the last extension of this Guarantee. If a claim has been received by us within the said date, all the rights of IGGL under this Guarantee shall be valid and shall not cease until we have satisfied that claim.

Yours faithfully,

\_\_\_\_\_  
Bank by its Constituted Attorney

Signature of a person duly  
Authorized to sign on behalf of the Bank  
E-mail:  
Telephone/Mobile No.:

INSTRUCTIONS FOR FURNISHING  
"PERFORMANCE SECURITY / SECURITY DEPOSIT" BY "BANK GUARANTEE"

1. The Bank Guarantee by successful Bidder(s) will be given on non-judicial stamp paper as per 'stamp duty' applicable. The non-judicial stamp paper should be in name of the issuing bank. In case of foreign bank, the said Bank Guarantee to be issued by its correspondent bank in India on requisite non-judicial stamp paper and place of Bid to be considered as Guwahati.
2. A letter from the issuing bank of the requisite Bank Guarantee confirming that said Bank Guarantee and all future communication relating to the Bank Guarantee shall be forwarded to Purchaser as per format appended below.
3. The Bank Guarantee shall be from any Indian scheduled bank or a branch of an international bank situated in India and registered with Reserve bank of India as scheduled foreign bank. However, in case of bank guarantees from banks other than the Nationalised Indian banks, the bank must be a commercial bank having net worth in excess of Rs 100 crores and a declaration to this effect shall be made by such commercial bank either in the Bank Guarantee itself or separately on its letterhead.
4. **THE BANK GUARANTEE ISSUED BY THE BANK MUST BE ROUTED THROUGH SFMS PLATFORM AS PER FOLLOWING DETAILS:**

"BG issuance message (IFN 760 / IFN760COV For issuance of BG and IFN 767 / IFN 767 COV FOR Amendment of BG) is to be transmitted through SFMS to beneficiary's bank as below:

Name of Bank	: Axis Bank
Branch	: Guwahati
Branch Address	: Chhibber House, Ground Floor, G.S Road, Guwahati -781005
IFSC	: UTIB0000140
SWIFT Code	: AXISINBB140

=====

The issuing bank while issuing/amending the BG, should ensure that the below information is correctly captured in the message i.e., IFN 760 / IFN 760COV / IFN 767/ IFN 767COV:

Field Number	Particulars
7037	IGGL938956645

NOTE: THE BANK GUARANTEE ISSUED BY THE BANK MUST BE ROUTED THROUGH SFMS PLATFORM AS PER FOLLOWING DETAILS:

- (i) IFN 760 / IFN 760COV FOR ISSUANCE OF BANK GUARANTEE
- (ii) IFN 767 / IFN 767 COV FOR AMENDMENT OF BANK GUARANTEE
- (iii) THE ABOVE MESSAGE / INTIMATION SHALL BE SENT THROUGH SFMS BY THE BG ISSUING BANK TO AXIS BANK, GUWAHATI BRANCH, IFSC CODE – UTIB0000140; BRANCH ADDRESS: Axis Bank, Chhibber House, Ground Floor, G.S Road, Guwahati - 781005
- (iv) THE SUPPLIER SHALL SUBMIT TO IGGL THE COPY OF SFMS MESSAGE AS SENT BY THE ISSUING BANK ALONG WITH THE ORIGINAL BANK GUARANTEE

**MATTER TO BE MENTIONED IN COVERING LETTER TO BE SUBMITTED BY VENDOR ALONG WITH BANK GUARANTEE**

1	<b>BANK GUARANTEE NO</b>	:				
2	<b>VENDOR NAME / VENDOR CODE</b>	:	<b>NAME</b>			
			<b>VENDOR CODE</b>			
3	<b>BANK GUARANTEE AMOUNT</b>	:				
4	<b>PURCHASE ORDER/ LOA NO</b>	:				
5	<b>NATURE OF BANK GUARANTEE</b>	:				
	<b>(Please Tick (✓) whichever is Applicable</b>		<b>PERFORMANCE BANK GUARANTEE</b>	<b>SECURITY DEPOSIT</b>	<b>EMD</b>	<b>ADVANCE</b>
6	<b>BG ISSUED BANK DETAILS</b>	(A)	<b>EMAIL ID:</b>			
(B)		<b>ADDRESS:</b>				
(C)		<b>PHONE NO.:</b>				

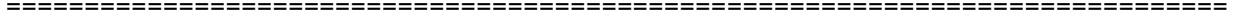

**SECTION-III**

**INSTRUCTION TO BIDDERS**

**[TO BE READ IN CONJUNCTION WITH BIDDING DATA SHEET (BDS)]**

**INSTRUCTION TO BIDDERS**

**INDEX**

- [A] GENERAL:**
1. SCOPE OF BID
  2. ELIGIBLE BIDDERS
  3. BIDS FROM CONSORTIUM
  4. ONE BID PER BIDDER
  5. COST OF BIDDING
  6. SITE-VISIT
- [B] TENDER DOCUMENT:**
7. CONTENTS OF TENDER DOCUMENT
  8. CLARIFICATION OF TENDER DOCUMENT
  9. AMENDMENT OF TENDER DOCUMENT
- [C] PREPARATION OF BID:**
10. LANGUAGE OF BID
  11. DOCUMENTS COMPRISING THE BID
  12. SCHEDULE OF RATES / BID PRICES
  13. GST (CGST & SGST/ UTGST or IGST)
  14. BID CURRENCIES
  15. BID VALIDITY
  16. EARNEST MONEY DEPOSIT (EMD)/ BID SECURITY
  17. PRE-BID MEETING
  18. FORMAT AND SIGNING OF BID
  19. ZERO DEVIATION & REJECTION CRITERIA
  20. E-PAYMENT
- [D] SUBMISSION OF BIDS:**
21. SUBMISSION, SEALING AND MARKING OF BID
  22. DEADLINE FOR SUBMISSION OF BID
  23. LATE BID
  24. MODIFICATION AND WITHDRAWAL OF BID
- [E] BID OPENING AND EVALUATION:**
25. PURCHASER'S RIGHT TO ACCEPT ANY BID AND TO REJECT ANY OR ALL BIDS
  26. BID OPENING
  27. CONFIDENTIALITY
  28. CONTACTING THE PURCHASER
  29. EXAMINATION OF BIDS AND DETERMINATION OF RESPONSIVENESS
  30. CORRECTION OF ERRORS
  31. CONVERSION TO SINGLE CURRENCY FOR COMPARISON OF BIDS
  32. EVALUATION AND COMPARISON OF BIDS
  33. QUANTITY VARIATION
  34. PURCHASE PREFERENCE

=====

**[F] AWARD OF CONTRACT:**

35. AWARD
36. NOTIFICATION OF AWARD / FAX OF ACCEPTANCE [FOA]
37. DISPATCH SCHEDULE
38. CONTRACT PERFORMANCE SECURITY / SECURITY DEPOSIT
39. PROCEDURE FOR ACTION IN CASE CORRUPT / FRAUDULENT/ COLLUSIVE/ COERCIVE PRACTICES
40. PUBLIC PROCUREMENT POLICY FOR MICRO AND SMALL ENTERPRISE
41. PACKING INSTRUCTIONS
42. VENDOR PERFORMANCE EVALUATION
43. MENTIONING OF PAN NO. IN INVOICE / BILL
44. DISPUTE RESOLUTION MECHANISM
45. DISPUTES BETWEEN CPSE'S/GOVERNMENT DEPARTMENT'S/ ORGANIZATIONS
46. REPEAT ORDER
47. PROMOTION OF PAYMENT THROUGH CARDS AND DIGITAL MEANS
48. PROVISION FOR STARTUPS
49. PROVISION REGARDING INVOICE FOR REDUCED VALUE OR CREDIT NOTE TOWARDS PRS
50. UNIQUE DOCUMENT IDENTIFICATION NUMBER BY PRACTICING CHARTERED ACCOUNTANTS
51. PROVISION W.R.T. TDS ON PURCHASE OF GOODS UNDER SECTION 194Q OF INCOME TAX ACT
52. DOCUMENTS FOR PAYMENT
53. RESTRICTING PARTICIPATION OF NCLT REFERRED BIDDERS

**[G] ANNEXURES:**

1. ANNEXURE-I: ADDENDUM TO INSTRUCTIONS TO BIDDERS (INSTRUCTION FOR PARTICIPATION IN E-TENDER)
2. ANNEXURE-II: BIDDING DATA SHEET (BDS)
3. ANNEXURE-III: POLICY FOR PURCHASE PREFERENCE TO PUBLIC PROCUREMENT (PREFERENCE TO MAKE IN INDIA (PPP-MII))
4. ANNEXURE-IV: PROCEDURE FOR ACTION IN CASE CORRUPT/FRAUDULENT/COLLUSIVE/COERCIVE PRACTICES
5. ANNEXURE-V: PROCEDURE FOR EVALUATION OF PERFORMANCE OF VENDORS/ SUPPLIERS/ CONTRACTORS/ CONSULTANTS

=====

**INSTRUCTIONS TO BIDDERS [ITB]**  
**(TO BE READ IN CONJUNCTION WITH BIDDING DATA SHEET (BDS))**

**[A] – GENERAL**

**1 SCOPE OF BID**

- 1.1 The Purchaser, as defined in the "General Conditions of Contract [GCC]", wishes to receive Bids as described in the Bid Document/Tender document issued by the Purchaser. Purchaser/Owner/IGGL occurring herein under shall be considered synonymous.
- 1.2 **SCOPE OF BID:** The scope of supply shall be as defined in the Tender document.
- 1.3 The successful bidder (the "Supplier") shall complete delivery of goods along with its incidental services (if any) as per specification, Scope of Supply/Job within the period stated in Special Conditions of Contract.
- 1.4 Throughout the Tender Documents, the terms 'Bid', 'Tender', 'Offer' & 'proposals' and their derivatives [Bidder/Tenderer, Bid/Tender/Offer etc.] are synonymous. Further, 'Day' means 'Calendar Day' and 'Singular' also means 'Plural'.

**2 ELIGIBLE BIDDERS:**

- 2.1 The Bidder shall not be under a declaration of ineligibility by Purchaser for Corrupt/ Fraudulent/ Collusive/ Coercive practices, as defined in "Instructions to Bidders [ITB], Clause No. 39" (Action in case Corrupt/ Fraudulent/ Collusive/ Coercive Practices).
- 2.2 The Bidder is not put on Holiday by IGGL or Public Sector Project Management Consultant (like EIL, MECON etc. only due to "poor performance" or "corrupt and fraudulent practices") or banned/blacklisted by Government department/Public Sector on due date of submission of bid. Further, neither bidder nor their allied agency/ (ies) (as defined in the Procedure for Action in case of Corrupt/ Fraudulent/ Collusive/ Coercive Practices) are on banning list of IGGL or the Ministry of Petroleum and Natural Gas.

If the tender document is/was issued inadvertently/ downloaded from website, then Bid submitted by such Bidder shall not be considered for opening/ evaluation/Award.

In case there is any change in status of the declaration prior to award of contract, the same has to be promptly informed to IGGL by the bidder.

It shall be the sole responsibility of the bidder to inform their status regarding para 1 of clause 2.2 herein above on due date of submission of bid and during the course of finalization of the tender. Concealment of the facts shall tantamount to misrepresentation of facts and shall lead to action against such Bidders as per clause 39 of ITB.

=====

2.3 Bidder shall not be affiliated with a firm or entity:

- (i) that has provided consulting services related to the work to the Purchaser during the preparatory stages of the work or of the project of which the works/services forms a part of or
- (ii) that has been hired (proposed to be hired) by the Purchaser as an Engineer/ Consultant for the contract.

2.4 Neither the firm/entity appointed as the Project Management Consultant (PMC) for a Project (except feasibility report) nor its affiliates shall be allowed to participate in the tendering process unless it is the sole Licensor/Licensor nominated agent/ vendor.

2.5 Pursuant to qualification criteria set forth in the Tender document, the Bidder shall furnish all necessary supporting documentary evidence to establish Bidder's claim of meeting qualification criteria.

2.6 **Power of Attorney:**

Power of Attorney (POA) to be issued by the bidder in favour of the authorised employee(s), in respect of the particular tender, for purpose of signing the documents including bid, all subsequent communications, agreements, documents etc. pertaining to the tender and act and take any and all decision on behalf of the bidder. Any consequence resulting due to such signing shall be binding on the Bidder.

The Power of Attorney shall be issued as per the constitution of the bidder as below:

- a) **In case of Proprietorship:** by Proprietor.
- b) **In case of Partnership:** by all Partners or Managing Partner.
- c) **In case of Limited Liability Partnership:** by any bidder's employee authorized in terms of Deed of LLP.
- d) **In case of Public / Limited Company:** PoA in favour of authorized employee(s) by Board of Directors through Board Resolution or by the designated officer authorized by Board to do so. Such Board Resolution should be duly countersigned by Company Secretary /MD / CMD / CEO.

The Power of Attorney should be valid till award of contract / order to successful Bidder.

2.7 In case of change of constitution of bidder after submission of bid, the same shall be informed by the bidder to IGGL promptly. Failure to same shall be considered as misrepresentation by the bidder.

3. **BIDS FROM "CONSORTIUM": NOT APPLICABLE**

4. **ONE BID PER BIDDER:**

4.1 A Bidder shall submit only 'one [01] Bid' in the same Bidding Process either as single entity or as a member of any consortium (wherever consortium bid is allowed). A Bidder who submits or participates in more than 'one [01] Bid' will cause all the proposals in which the Bidder has participated to be disqualified.

=====

4.2 A bidder shall not have conflict of interest with other bidders. Such conflict of interest can lead to anti-competitive practices. The bidder found to have a conflict of interest shall be disqualified. A bidder shall be considered to have a conflict of interest with one or more bidders in this bidding process, if:

- a) they have controlling partner (s) in common; or
- b) they receive or have received any direct or indirect subsidy/ financial stake from any of them; or
- c) they have the same legal representative/authorized signatory/agent for purposes of this bid; or
- d) they have relationship with each other, directly or through common third parties, that puts them in a position to have access to information about or influence on the bid of another Bidder; or
- e) Bidder participates in more than one bid in bidding process. Participation by a Bidder in more than one Bid will result in the disqualification of all bids in which the parties are involved. However, this does not limit the inclusion of the components/ sub-assembly/Assemblies from one bidding manufacturer in more than one bid.
- f) a Bidder or any of its affiliates participated as a consultant in the preparation of the design or technical specifications of the contract that is the subject of the Bid;
- g) In case of a holding company having more than one independently manufacturing units, or more than one unit having common business ownership/management, only one unit should quote. Similar restrictions would apply to closely related sister companies. Bidders must proactively declare such sister/ common business/ management units in same/ similar line of business.

Bidders are required to submit a confirmation for no conflict of interest with other bidders in Format F-5.

4.3 Alternative Bids shall not be considered.

4.4 The provisions mentioned at Sl. no. 4.1 and 4.2 shall not be applicable wherein bidders are quoting for different Items / Sections / Parts / Groups/ SOR items of the same tender which specifies evaluation on Items / Sections / Parts / Groups/ SOR items basis.

5. **COST OF BIDDING:**

The Bidder shall bear all costs associated with the preparation and submission of the Bid including but not limited to Documentation Charges, Bank charges, all courier charges, translation charges, authentication charges and any associated charges including taxes & duties thereon. Further, IGGL will in no case, be responsible or liable for these costs, regardless of the outcome of the bidding process.

6. **SITE VISIT:**

6.1 The Bidder is advised to visit and examine the site and its surroundings and obtain for itself on its own responsibility all information that may be necessary for preparing the Bid and entering into a Contract for the required supply/job. The costs of visiting the site shall be borne by the Bidder.

- =====
- 6.2 The Bidder or any of its personnel or agents shall be granted permission by the Employer to enter upon its premises and land for the purpose of such visits, but only upon the express conditions that the Bidder, its personnel and agents will release and indemnify the Employer and its personnel, agents from and against all liabilities in respect thereof, and will be responsible for death or injury, loss or damage to property, and any other loss, damage, costs, and expenses incurred as a result of inspection.
- 6.3 The Bidder shall not be entitled to hold any claim against IGGL for non-compliance due to lack of any kind of pre-requisite information as it is the sole responsibility of the Bidder to obtain all the necessary information with regard to site, surrounding, working conditions, weather etc. on its own before submission of the bid.

## **[B] – BIDDING DOCUMENTS**

### **7 CONTENTS OF BIDDING DOCUMENTS**

- 7.1 The contents of Bidding Documents / Tender Documents are those stated below and should be read in conjunction with any 'Addendum / Corrigendum' issued in accordance with "ITB: Clause-8 & 9":
- Section-I: Invitation for Bid [IFB]\*
  - Section-II: BID EVALUATION CRITERIA [BEC] & Evaluation methodology
  - Section-III: Instructions to Bidders [ITB], Annexures
  - Section-IV: General Conditions of Contract [GCC]
  - Section-V: Forms & Format
  - Section-VI: Special Conditions of Contract [SCC], Scope of Supply
  - Section-VII: Schedule of Rates

\*Request for Quotation', wherever applicable, shall also form part of the Bidding Document.

- 7.2 The Bidder is expected to examine all instructions, forms, terms & conditions of the Tender Document. The RFQ & IFB together with all its attachments thereto, shall be considered to be read, understood and accepted by the Bidders. Failure to furnish all information required by the Tender Document or submission of a Bid not substantially responsive to the Tender Document in every respect will be at Bidder's risk and may result in the rejection of his Bid.

### **8. CLARIFICATION OF TENDER DOCUMENTS:**

- 8.1 A prospective Bidder requiring any clarification(s) of the Tender Document may notify IGGL in writing or by email in the format "F-9" at IGGL's mailing address indicated in the IFB/BDS no later than 02 (two) days prior to pre-bid meeting (in cases where pre-bid meeting is scheduled) or 05 (five) days prior to the bid closing date in cases where pre-bid meeting is not scheduled. IGGL reserves the right to ignore the bidders request for clarification if received after the aforesaid period. IGGL may respond in writing to the request for clarification. IGGL's response including an

=====

explanation of the query, but without identifying the source of the query will be uploaded on CPP portal.

- 8.2 Any clarification or information required by the Bidder but same not received by the Purchaser as per instruction at clause 8.1 above is liable to be considered as "no clarification / information required".

## **9. AMENDMENT OF TENDER DOCUMENT:**

- 9.1 At any time prior to the 'Due Date & Time of Bid Submission', Purchaser may, for any reason, whether at its own initiative or in response to a clarification requested by a prospective Bidder(s), modify the Tender Documents by addenda/ corrigendum.
- 9.2 Any addendum/ corrigendum thus issued shall be integral part of the Tender Document and shall be uploaded CPP Portal. Bidders have to take into account all such addendum/ corrigendum before submitting their Bid.
- 9.3 The Purchaser, if consider necessary, may extend the Bid Due Date in order to allow the Bidders a reasonable time to furnish their most competitive bid taking into account the addenda/corrigendum issued thereof.

---

## **[C] – PREPARATION OF BIDS**

### **10 LANGUAGE OF BID:**

The bid prepared by the Bidder and all correspondence, drawing(s), document(s), certificate(s) etc. relating to the Bid exchanged by Bidder and IGGL shall be written in English language only. In case a document, certificate, printed literature etc. furnished by the Bidder in a language other than English, the same should be accompanied by an English translation duly authenticated by the Chamber of Commerce, in which case, for the purpose of interpretation of the Bid, the English translation shall govern.

### **11. DOCUMENTS COMPRISING THE BID:**

- 11.1 All pages of the Bid must be signed by the "authorized signatory" of the Bidder holding Power of Attorney. The Bid must be submitted on CPP portal as follows:

#### **11.1.1 PART-I: "TECHNO-COMMERCIAL/UN-PRICED BID"**

- (a) 'Covering Letter' on Bidder's 'Letterhead' clearly specifying the enclosed contents with index.
- (b) 'Bidder's General Information', as per 'Form F-1'.
- (c) Copy of Price Schedule/ Schedule of Rate (SOR) with prices blanked out but mentioning "Quoted" / "Not Quoted" (as applicable) written against each item, in support of having submitted prices in the Priced Bid/SOR strictly in the format provided in the Tender Document.
- (d) 'Letter of Authority' on the Letter Head, as per 'Form F-3'

- =====
- (e) 'Agreed Terms and Conditions', as per 'Form F-5'.
  - (f) Duly certified / attested documents in accordance with the "Bid Evaluation Criteria [BEC]", Section-II of Tender Document.
  - (g) Copy of Power of Attorney in favour of the authorized signatory of the Bid, as per clause no.2.6 of ITB.
  - (h) Any other information/details required as per Tender Document.
  - (i) Copy of EMD/Declaration of Bid Security, as per clause 16 of ITB.
  - (j) Undertaking as per Form-I-A to Section-II and Form-I-B to Section-II regarding Provisions for Procurement from a Bidder which shares a land border with India.
  - (k) Integrity Pact (if applicable)
  - (l) Undertaking as per Form-1 to Annexure-III to Section-III by MSE bidders and Class I Bidders seeking preference under policy to provide purchase preference as per public procurement (preference to make in India), Order 2017 (PPP-MII), if applicable.
  - (m) Undertaking as per Form-2 to Annexure-III to Section-III and Certification from the statutory auditor or cost auditor of the company (in the case of companies) or from a practicing cost accountant or practicing chartered accountant (in respect of other than companies) as per Form-3 to Annexure-III to Section-III.
  - (n) All other Forms and Formats including Annexures.
  - (o) Tender Document, its Corrigendum/Amendment/Clarification(s) duly signed by the Authorized Signatory holding POA.
  - (p) Additional document specified in BDS, SCC, Scope of Supply or mentioned elsewhere in the Tender Document.

**Note: All the pages of the Bid must be signed by the "Authorized Signatory" of the Bidder holding POA.**

Further, Bidders must submit the original "Bid Security / EMD", Power of Attorney, Integrity Pact and any other documents specified in the Tender Document to the address mentioned in IFB, in a sealed envelope, superscribing the details of Tender Document (i.e. tender number & tender for) within 7 days from the Bid Due Date.

Bidders are required to submit the EMD in original by Bid Due Date and Time or upload a scanned copy of the same in the Part-I of the Bid. If the Bidder is unable to submit EMD in original by Bid Due Date and Time, the Bidder is required to upload a scanned copy of the EMD in Part-I of Bid, provided the original EMD, copy of which has been uploaded, is received within 7 days from the Bid Due Date, failing which the Bid will be rejected irrespective of their status/ranking in tendering process and notwithstanding the fact that a copy of EMD was earlier uploaded by the Bidder.

=====

## 11.1.2 PART-II: Price Bid

- i) The Prices are to be submitted strictly as per the Price bid / Schedule of Rate (SOR) on CPP portal. IGGL shall not be responsible for any failure on the part of the bidder to follow the instructions.
- ii) Bidders are advised NOT to mention Rebate/Discount separately, either in the SOR format or anywhere else in the offer. In case Bidder(s) intend to offer any Rebate/Discount, they should include the same in the item rate(s) itself under the "Schedule of Rates (SOR)" and indicate the discounted unit rate(s) only.
- iii) If any unconditional rebate has been offered in the quoted rate the same shall be considered in arriving at evaluated price. However, no cognizance shall be taken for any conditional discount for the purpose of evaluation of the bids.
- iv) In case, it is observed that any of the Bidder(s) has/have offered suo-moto Discount/Rebate after opening of unpriced bid but before opening of price bid, such discount /rebate(s) shall not be considered for evaluation. However, in the event of the Bidder emerging as the lowest evaluated Bidder without considering the discount/rebate(s), then such discount/ rebate(s) offered by the Bidder shall be considered for Award and the same will be conclusive and binding on the Bidder.
- v) In the event as a result of techno-commercial discussions or pursuant to seeking clarifications / confirmations from bidders, while evaluating the un-priced part of the bid, any of the bidders submits a sealed envelope stating that it contains revised prices; such bidder(s) will be requested to withdraw the revised prices failing which the bid will not be considered for further evaluation.

## 12 SCHEDULE OF RATES / BID PRICES

- 12.1 Prices must be filled exactly in the format for "Price Schedule / Schedule of Rates (SOR)" enclosed as part of Tender Document. As stated elsewhere in tender, bidder is required to quote all components of Price Schedule. In case it is found that some of the components of Price schedule viz. Freight, Ocean/Air Freight Charges, Incidental Services Component, etc. are left blank or quoted "Nil/Zero" in Price Bid, the same shall be considered inclusive in total quoted price for evaluation and ordering. No confirmation from the bidder shall be sought in this regard.
- 12.2 The delivery basis of the goods is mentioned in BDS. If the Goods are dispatched through dedicated full truck load, date of receipt of Goods by Purchaser at its designated site(s) /Store shall be considered as the date of delivery. Similarly, in case of break-bulk dispatches, the date of LR/GR shall be considered as date of delivery. The delivery terms [other than those mentioned in BDS] shall be interpreted as per INCOTERMS®2020 or its latest version.
- 12.3 All duties, taxes and other levies (if any) payable by the Seller under the Contract or for any other cause, except GST (CGST & SGST/UTGST or IGST) on finished product & on the incidental services, shall be included in the rates / prices and the total bid-price submitted by the Bidder. The quoted rate of GST on finished product & on the incidental services shall be indicated in the bid prices. Bidders are required to quote the prices after carefully reading the provisions mentioned in tender document including SCC, GCC, Scope of Supply, etc.

=====  
12.4 Prices quoted by the Bidder, shall remain firm and fixed and valid till completion of the Contract and will not be subject to variation on any account, whatsoever, unless any price escalation/variation is allowed elsewhere in the Tender Document.

### **13. GST (CGST & SGST/ UTGST or IGST)**

13.1 Bidders are required to mention the GST registration no. in bids wherever GST is applicable.

13.2 Quoted prices should be inclusive of all taxes and duties, except GST (CGST & SGST or IGST or UTGST). Please note that the responsibility of payment of GST (CGST & SGST or IGST or UTGST) lies with the Supplier only. Supplier providing taxable service shall issue an e-Invoice/Invoice/ Bill, as the case may be as per rules/ regulation of GST. Further, returns and details required to be filled under GST laws & rules should be timely filed by Service Provider with requisite details. Payments to Supplier for claiming GST (CGST & SGST/UTGST or IGST) amount will be made provided the above formalities are fulfilled. Further, IGGL may seek copies of challan and certificate from Chartered Accountant for deposit of GST (CGST & SGST/UTGST or IGST) collected from Owner.

13.3 In case CBIC (Central Board of Indirect Taxes and Customs)/ any tax authority / any equivalent government agency brings to the notice of IGGL that the Supplier has not remitted the amount towards GST (CGST & SGST/UTGST or IGST) collected from IGGL to the government exchequer, then, that Supplier shall be put under Holiday list of IGGL for period of six months after following the due procedure. This action will be in addition to the right of recovery of financial implication arising on IGGL.

13.4 In case of statutory variation in **GST (CGST & SGST/UTGST or IGST)**, other than due to change in turnover, payable on the contract value during contract period, the Supplier shall submit a copy of the 'Government Notification' to evidence the rate as applicable on the Bid due date and on the date of revision.

Beyond the contract period, in case IGGL is not entitled for input tax credit of **GST (CGST & SGST/UTGST or IGST)**, then any increase in the rate of **GST (CGST & SGST/UTGST or IGST)** beyond the contractual delivery period shall be to Supplier's account whereas any decrease in the rate **GST (CGST & SGST/UTGST or IGST)** shall be passed on to the Owner.

Beyond the contract period, in case IGGL is entitled for input tax credit of **GST (CGST & SGST/UTGST or IGST)**, then statutory variation in quoted **GST (CGST & SGST/UTGST or IGST)** on supply and on incidental services, shall be to IGGL's account.

Claim for payment of **GST (CGST & SGST/UTGST or IGST)**/ Statutory variation, should be raised within two [02] months from the date of issue of 'Government Notification' for payment of differential (in %) **GST (CGST & SGST/UTGST or IGST)**, otherwise claim in respect of above shall not be entertained for payment of arrears.

The base date for the purpose of applying statutory variation shall be the Bid Due Date.

13.5 Where IGGL is entitled to avail the input tax credit of **GST (CGST & SGST/UTGST or IGST)**:

13.5.1 Owner/ IGGL will reimburse the **GST (CGST & SGST/UTGST or IGST)** to the Supplier at actuals against submission of E-Invoices/Invoices as per format specified in rules/ regulation of GST to enable Owner/ IGGL to claim input tax credit of **GST (CGST & SGST/UTGST or IGST)** paid. In case of any variation in the executed quantities, the amount on which the **GST (CGST & SGST/UTGST or IGST)** is applicable shall be modified in same proportion. Returns and details required to be

=====

filled under GST laws & rules should be timely filed by supplier with requisite details.

13.5.2 The input tax credit of quoted **GST (CGST & SGST/UTGST or IGST)** shall be considered for evaluation of bids, as per evaluation criteria of tender document.

13.6 Where IGGL is not entitled to avail/take the full input tax credit of **GST (CGST & SGST/UTGST or IGST)**:-

13.6.1 Owner/ IGGL will reimburse **GST (CGST & SGST/UTGST or IGST)** to the Supplier at actuals against submission of E-Invoices/Invoices as per format specified in rules/ regulation of GST subject to the ceiling amount of **GST (CGST & SGST/UTGST or IGST)** as quoted by the bidder, subject to any statutory variations, except variations arising due to change in turnover. In case of any variation in the executed quantities (If directed and/or certified by the Engineer-In-Charge) the ceiling amount on which **GST (CGST & SGST/UTGST or IGST)** is applicable will be modified on pro-rata basis.

13.6.2 The bids will be evaluated based on total price including quoted **GST (CGST & SGST/UTGST or IGST)**.

13.7 IGGL will prefer to deal with registered supplier of goods/ services under GST. Therefore, bidders are requested to get themselves registered under GST, if not registered yet. However, in case any unregistered bidder is submitting their bid, Bids will be evaluated as per quoted prices without loading of GST (CGST & SGST/UTGST or IGST), if not quoted. Further, an unregistered bidder is required to mention its Income Tax PAN in bid document.

13.8 In case IGGL is required to pay entire/certain portion of applicable GST (CGST & SGST/UTGST or IGST) and remaining portion, if any, is to be deposited by Bidder directly as per GST (CGST & SGST/UTGST or IGST) laws, entire applicable rate/amount of GST (CGST & SGST/UTGST or IGST) to be indicated by bidder in the SOR.

Where IGGL has the obligation to discharge GST (CGST & SGST/UTGST or IGST) liability under reverse charge mechanism and IGGL has paid or is /liable to pay GST (CGST & SGST/UTGST or IGST) to the Government on which interest or penalties becomes payable as per GST laws for any reason which is not attributable to IGGL or ITC with respect to such payments is not available to IGGL for any reason which is not attributable to IGGL, then IGGL shall be entitled to deduct/ setoff / recover such amounts against any amounts paid or payable by IGGL to Service Provider / Supplier.

13.9 Supplier shall ensure timely submission of correct invoice(s)/e-invoice(s), as per GST rules/ regulation, with all required supporting document(s) within a period specified in Contract to enable IGGL to avail input credit of GST (CGST & SGST/UTGST or IGST). Further, returns and details required to be filled under GST laws & rules should be timely filed by Supplier with requisite details.

If input tax credit is not available to IGGL for any reason not attributable to IGGL, then IGGL shall not be obligated or liable to pay or reimburse GST (CGST & SGST/UTGST or IGST) claimed in the invoice(s) and shall be entitled to deduct / setoff / recover such GST amount (CGST & SGST/UTGST or IGST) or Input Tax Credit amount together with penalties and interest, if any, against any amounts paid or becomes payable by IGGL in future to the Supplier under this contract or under any other contract.

=====

## 13.10 Anti-profiteering clause

As per Clause 171 of GST Act, it is mandatory to pass on the benefit due to reduction in rate of tax or from input tax credit to the consumer by way of commensurate reduction in prices. The Supplier may note the above and quote their prices accordingly.

13.11 In case the GST rating of Supplier on the GST portal / Govt. official website is negative / blacklisted, then the bids may be rejected by IGGL. Further, in case rating of bidder is negative / blacklisted after award of work, then IGGL shall not be obligated or liable to pay or reimburse GST to such Supplier and shall also be entitled to deduct / recover such GST along with all penalties / interest, if any, incurred by IGGL.

13.12 GST, as quoted by the bidder in Schedule of Rates, shall be deemed as final and binding for the purpose of bid evaluation (applicable for tenders where bidder quotes the GST rates). In case a bidder enters "zero/blank" GST or an erroneous GST, the bid evaluation for finalizing the L1 bidder will be done considering the "zero" or quoted GST rate, as the case may be. No request for change in GST will be entertained after submission of bids.

In cases where the successful bidder quotes a wrong GST rate, for releasing the order, the following methodology will be followed:

- In case the actual GST rate applicable is lower than the quoted GST rate, the actual GST rate will be added to the quoted basic prices. The final cash outflow will be based on actual GST rate.
- In case the actual GST rate applicable is more than the quoted GST rate, the basic prices quoted will be reduced proportionately, keeping the final cash outflow the same as the overall quoted amount.

Based on the total cash outflow calculated as above, IGGL shall place orders.

13.13 Wherever TDS under GST Laws has been deducted from the invoices raised / payments made to the vendors, as per the provisions of the GST law / Rules, Vendors should accept the corresponding GST-TDS amount populated in the relevant screen on GST common portal ([www.gst.gov.in](http://www.gst.gov.in)). Further, Vendors should also download the GST TDS certificate from GST common portal (reference path: Services > User Services > View/Download Certificates option).

## 13.14 Provision w.r.t. E- Invoicing requirement as per GST laws:

Supplier who is required to comply with the requirements of E-invoice for B2B transactions as per the requirement of GST Law will ensure the compliance of requirement of E Invoicing under GST law. If the invoice issued without following this process, such invoice can-not be processed for payment by IGGL as no ITC is allowed on such invoices.

Therefore, all the payments to such supplier who is liable to comply with e-invoice as per GST Laws shall be made against the proper e-invoice(s) only. Further, returns and details required to be filled under GST laws & rules against such e-invoices should be timely filed by Supplier of Goods with requisite details.

If input tax credit is not available to IGGL for any reason attributable to supplier (both for E-invoicing cases and non-E-invoicing cases), then IGGL shall not be obligated or liable to pay or reimburse GST (CGST & SGST/UTGST or IGST) claimed in the invoice(s) and shall be entitled to deduct / setoff / recover such GST amount (CGST & SGST/UTGST or IGST) or Input Tax Credit amount together with penalties and interest, if any, by adjusting against any amounts paid or becomes payable in future to the supplier under this contract or under any other contract.

To ensure compliance, undertaking in requisite format is to be submitted by supplier as per format F-14 along with documents for release of payment.

=====

## 13.15 **New taxes & Duties:**

Any new taxes & duties, if imposed by the State/ Central Govt. of India after the due date of bid submission but before the Contractual Completion Date, shall be reimbursed to the Supplier on submission of copy of notification(s) issued from State/ Central Govt. Authorities along with documentary evidence for proof of payment of such taxes & duties, but only after ascertaining it's applicability with respect to the Contract.

13.16 Full payment including GST will be released at the time of processing of invoice for payment, where the GST amount reflects in Form GSTR-2A of IGGL. However, in case where the GST amount doesn't reflect in Form GSTR-2A of IGGL, the amount of GST will be released after reflection of GST amount of corresponding invoice in Form GSTR-2A of IGGL.

## 14. **BID CURRENCIES:**

Bidders must submit bid in Indian Rupees only.

## 15. **BID VALIDITY:**

15.1 Bid shall be kept valid for period specified in BDS from the final "Bid Due Date". A Bid valid for a shorter period may be rejected by IGGL as 'non-responsive'.

15.2 In exceptional circumstances, prior to expiry of the original 'Bid Validity Period', the Purchaser may request the Bidders to extend the 'Period of Bid Validity' for a specified additional period. The request and the responses thereto shall also be made in writing or by email. Bidder may refuse the request without forfeiture of his EMD/Bid Security. A Bidder agreeing to the request will not be required or permitted to modify his Bid but will be required to extend the validity of its EMD (if applicable) for the period of the extension and in accordance with "ITB: Clause-16" in all respects.

## 16. **EARNEST MONEY DEPOSIT (IF APPLICABLE):**

16.1 Bid must be accompanied with earnest money deposit (**i.e. Earnest Money Deposit (EMD)** also known as **Bid Security**) in the form of '**Demand Draft**' / '**Banker's Cheque**'/'**Insurance Surety Bond**'/'**Fixed Deposit Receipt**' [in favour of **Indradhanush Gas Grid Limited** payable at place mentioned in **BDS**] or '**Bank Guarantee (including e-Bank Guarantee)**' strictly as per the format given in form F-2 of the **Tender Document**. Bidder shall ensure that EMD submitted in the form of '**Bank Guarantee (including e-Bank Guarantee)**' should have a validity of at least 'two [02] months' beyond the validity of the Bid. EMD submitted in the form of '**Demand Draft**' or '**Banker's Cheque**' should be valid for three months.

Bid not accompanied with EMD, or EMD not in requisite format shall be liable for rejection. The EMD shall be submitted in Indian Rupees only.

**NOTE: THE BANK GUARANTEE ISSUED BY THE BANK MUST BE ROUTED THROUGH SFMS PLATFORM AS PER FOLLOWING DETAILS:**

"BG issuance message (IFN 760 / IFN760COV For issuance of BG and IFN 767 / IFN 767 COV FOR Amendment of BG) is to be transmitted through SFMS to beneficiary's bank as below:

Name of Bank : Axis Bank

Branch : Guwahati

Branch Address: Chhibber House, Ground Floor, G.S Road, Guwahati -781005

IFSC : UTIB0000140

SWIFT Code : AXISINBB140

=====

The issuing bank while issuing/amending the BG, should ensure that the below information is correctly captured in the message i.e., IFN 760 / IFN 760COV / IFN 767/ IFN 767COV:

Field Number	Particulars
7037	IGGL938956645

NOTE: THE BANK GUARANTEE ISSUED BY THE BANK MUST BE ROUTED THROUGH SFMS PLATFORM AS PER FOLLOWING DETAILS:

- (i) IFN 760 / IFN 760COV FOR ISSUANCE OF BANK GUARANTEE
- (ii) IFN 767 / IFN 767 COV FOR AMENDMENT OF BANK GUARANTEE
- (iii) THE ABOVE MESSAGE / INTIMATION SHALL BE SENT THROUGH SFMS BY THE BG ISSUING BANK TO AXIS BANK, GUWAHATI BRANCH, IFSC CODE – UTIB0000140; BRANCH ADDRESS: Axis Bank, Chhibber House, Ground Floor, G.S Road, Guwahati - 781005
- (iv) THE SUPPLIER SHALL SUBMIT TO IGGL THE COPY OF SFMS MESSAGE AS SENT BY THE ISSUING BANK ALONG WITH THE ORIGINAL BANK GUARANTEE

16.2 The bidder can also submit the EMD through online banking transaction i.e. IMPS/NEFT/RTGS etc. For this purpose, the details of IGGL's Bank Account are mentioned under BDS. While remitting, the bidder must indicate EMD and tender/E-tender no. under remarks. Bidders shall be required to submit/ upload the successful transaction details along-with their bid/e-bid in addition to forwarding the details to dealing officer through email/letter with tender reference number immediately after remittance of EMD.

In absence of submitting/ uploading the remittance details, the bid is likely to be considered as bid not accompanied with EMD. Further, in case of the online transaction, submission of EMD in original is not applicable.

16.3 IGGL shall not be liable to pay any documentation charges, Bank charges, commission, interest etc. on the amount of EMD. In case EMD is in the form of a 'Bank Guarantee', the same shall be from any Indian scheduled Bank or a branch of an International Bank situated in India and registered with 'Reserve Bank of India' as Scheduled Foreign Bank. However, in case of 'Bank Guarantee' from Banks other than the Nationalized Indian Banks, the Bank must be commercial Bank having net worth in excess of Rs. 100 Crores [Rupees One Hundred Crores] and a declaration to this effect should be made by such commercial Bank either in the 'Bank Guarantee' itself or separately on its letterhead. Purchaser will verify the BG from issuing bank.

16.4 Any Bid not secured in accordance with "ITB: Clause-16.1. 16.2 & Clause-16.3" may be rejected by IGGL as non-responsive.

16.5 Unsuccessful Bidder's EMD will be discharged / returned as promptly as possible, but not later than 'thirty [30] days' after finalization of tendering process.

16.6 The successful Bidder's EMD will be discharged upon the Bidder's acknowledging the 'Award' and signing the 'Agreement' and furnishing the 'Contract Performance Security (CPS)/ Security Deposit' pursuant to clause no. 38 of ITB.

- =====
- 16.7 Notwithstanding anything contained herein, the EMD may also be forfeited in any of the following cases:
- (a) If a Bidder withdraws his Bid during the 'Period of Bid Validity'
  - (b) If a Bidder has indulged in corrupt/fraudulent /collusive/coercive practice
  - (c) If the Bidder modifies Bid during the period of bid validity (after Due Date and time for Bid Submission).
  - (d) Violates any other condition, mentioned elsewhere in the Tender Document, which may lead to forfeiture of EMD.
  - (e) In the case of a successful Bidder, if the Bidder fails to:
    - (i) to acknowledge receipt of the "Notification of Award" / Fax of Acceptance [FOA]",
    - (ii) to furnish "Contract Performance Security / Security Deposit", in accordance with "ITB: Clause-38"
    - (iii) to accept 'arithmetical corrections' as per provision of the clause 30 of ITB.
- 16.8 In case EMD is in the form of 'Bank Guarantee', the same must indicate the Tender Document No. and the name of Tender Document for which the Bidder is quoting. This is essential to have proper correlation at a later date.
- 16.9 MSEs (Micro & Small Enterprises) are exempted from submission of EMD in accordance with the provisions of PPP-2012 and Clause 40 of ITB. However, Traders / Dealers / Distributors /Stockiest /Wholesaler are not entitled for exemption of EMD. The Government Departments/PSUs are also exempted from the payment of EMD. Further, Startups are also exempted from the payment of EMD.
- 16.10 In case of forfeiture of EMD/ Bid Security, the forfeited amount will be considered inclusive of tax and tax invoice will be issued by IGGL. The forfeiture amount will be subject to final decision of IGGL based on other terms and conditions of order/contract."
- 16.11 EMD / Bid Bond will not be accepted in case the same has reference of 'remitter' /'financer' other than bidder on the aforementioned financial instrument of EMD / Bid Bond submitted by the bidder and bid of such bidder will be summarily rejected.
- 16A **DECLARATION FOR BID SECURITY**
- Bidder to whom exemption is allowed as per Clause no. 16.9 above are required to submit Declaration for Bid Security as per proforma at Form F-2A.
- 17. PRE-BID MEETING (IF APPLICABLE): Refer Invitation for Bid (IFB)**
- 17.1 The Bidder(s) or his designated representative are invited to attend a "Pre-Bid Meeting" which will be held at Date, Time & Venue as specified in IFB. It is expected that a bidder shall not depute more than 02 representatives for the meeting.

=====

If situation demands, pre-bid meeting will be held online. Bidders interested in attending the pre-bid meeting online, shall contact IGGL at the following e-mail ID's requesting IGGL for providing the link for online pre-bid meeting:

[kulajit.talukdar@iggl.co.in](mailto:kulajit.talukdar@iggl.co.in)

[tanveer.jalal@iggl.co.in](mailto:tanveer.jalal@iggl.co.in)

[debashish.boruah@iggl.co.in](mailto:debashish.boruah@iggl.co.in)

[cnp.department@iggl.co.in](mailto:cnp.department@iggl.co.in)

- 17.2 Purpose of the meeting will be to clarify issues and to answer questions on any matter that may be raised at that stage. The Bidder must submit their queries / clarifications to IGGL in the format "F-11", as mentioned in clause no. 8.0 of ITB.
- 17.3 The Text of the questions raised and the responses that may become necessary as a result of the Pre-Bid Meeting, will be prepared in the form of Addendum / Corrigendum / Clarification to the Tender Document and will be uploaded on CPP Portal and not through the minutes of the Pre-Bid Meeting.
- 17.4 Non-attendance of the Pre-Bid Meeting will not be a cause for disqualification of Bidder.

## **18. FORMAT AND SIGNING OF BID**

- 18.1 The Bid shall be typed or written in indelible ink [in the case of copies, photocopies are also acceptable] and shall be signed by a person or persons duly authorized to sign on behalf of the Bidder (as per POA). The name and position held by each person signing, must be typed or printed below the signature. All pages of the Bid except for unamendable printed literature where entry(s) or amendment(s) have been made shall be initiated by the person or persons signing the Bid.
- 18.2 The Bid shall contain no alterations, omissions, or additions, unless such corrections are initiated by the person or persons signing the Bid.
- 18.3 Digitally signed documents to be uploaded as detailed in addendum to ITB.

## **19. ZERO DEVIATION AND REJECTION CRITERIA:**

- 19.1 **ZERO DEVIATION:** Deviation to terms and conditions of Tender Document may lead to rejection of bid. IGGL will accept bids based on terms & conditions of Tender Document only. Bidder may note IGGL will determine the substantial responsiveness of each bid to the Tender Documents pursuant to provision contained in clause 29 of ITB. For purpose of this, a substantially responsive bid is one which conforms to all terms and conditions of the Tender Document without deviation (s) or exception (s). IGGL's determination of a bid's responsiveness is based on the content of the bid itself without recourse to extrinsic evidence.

Bidder is requested to not to take any deviation (s) / exception (s) to the terms and conditions of Tender Document, and submit all requisite documents as mentioned in this Tender Documents, failing which their offer will be liable for rejection. If a bidder does not reply to the queries in the permitted time frame, then its bid shall be evaluated based on the documents available in the bid.

=====

As a principle, clarifications from bidders after opening of tenders will not be sought. However, where clarifications / documents from the bidders on important aspects are absolutely necessary for finalization of tender, clarifications from bidder can be asked. The request for clarification shall be given in email/portal, asking the bidder to respond by a specified date, and also mentioning therein that, if the bidder does not comply or respond by the date, his tender will be liable to be rejected. Depending on the outcome, such tenders are to be ignored or considered further. No change in prices or substance of the bid including specifications, shall be offered or permitted. No post-bid clarification at the initiative of the bidder shall be entertained. The shortfall information/ documents should be sought only in case of historical documents which pre-existed bids and which have not undergone change since then.

19.2 **REJECTION CRITERIA:** Notwithstanding the above, deviation to the following clauses of Tender document shall lead to summarily rejection of Bid:

- (a) Firm Price
- (b) Earnest Money Deposit / Bid Security/ Bid Security Declaration (As applicable)
- (c) Specifications
- (d) Schedule of Rates / Price Schedule / Price Basis
- (e) Delivery Period / Period of Contract/ Completion schedule
- (f) Period of Validity of Bid
- (g) Price Reduction Schedule
- (h) Contract Performance Security / Security Deposit
- (i) Warranty / Guarantee
- (j) Arbitration / Resolution of Dispute/Jurisdiction of Court
- (k) Force Majeure & Applicable Laws
- (l) Integrity Pact, if Applicable
- (m) Any other condition specifically mentioned in the tender document elsewhere that non-compliance of the clause lead to rejection of bid

**Note:** Further, it is once again reminded not to mention any condition in the Bid which is contradictory to the terms and conditions of Tender document.

## 20. **E-PAYMENT**

IGGL has initiated payments electronically to Suppliers / Contractors electronically through '**e-banking**'.

=====

## **ID1 – SUBMISSION OF BIDS**

### **21. SUBMISSION, SEALING AND MARKING OF BIDS**

- 21.1 Bid shall be submitted through CPP Portal only in the manner specified in Tender Document. No Manual/Hard Copy (Original)/E-mail Bid shall be acceptable.
- 21.2 EMD/Physical documents shall be addressed to the owner at address specified in IFB.
- 21.3 Bids submitted under the name of AGENT/ REPRESENTATIVE /RETAINER/ ASSOCIATE etc. on behalf of a bidder/affiliate shall not be accepted.

### **22. DEADLINE FOR SUBMISSION OF BIDS:**

- 22.1 The Bid must be uploaded on CPP Portal only not later than the Bid Due Date & Time specified in IFB of the Tender Documents.
- 22.2 IGGL may, in exceptional circumstances and at its discretion, extend the Due Date & Time for Bid submission through a corrigendum as per clause no. 8.0 or 9.0 of ITB. In that case all rights and obligations of IGGL and the Bidders, previously subject to the original Due Date & Time will thereafter be subject to the Due Date & Time as extended. Such corrigendum for extension of Due Date & Time of Bid submission will be uploaded on the CPP portal.

### **23. LATE BIDS:**

- 23.1 CPP portal shall close immediately after the due date and time for submission of bid and no bids can be submitted thereafter.  
In case the EMD /physical documents have been received but the Bid is not submitted by the bidder in the CPP Portal, such EMD/ physical documents shall be returned immediately.
- 23.2 EMD /physical documents received to address other than one specifically stipulated in the Tender Document will not be considered for evaluation/opening/award if not received to the specified destination within stipulated date & time.

### **24. MODIFICATION AND WITHDRAWAL OF BIDS**

- 24.1 The bidder may withdraw or modify its bid after bid submission but before the Bid Due Date and Time.
- 24.2 No bid shall be modified/ withdrawn after the Bid Due Date & Time.
- 24.3 Any withdrawal/ modification/substitution of Bid in the interval between the Bid Due Date & Time and the expiration of the period of bid validity specified by the Bidder in their Bid shall result in

=====

the Bidder's forfeiture of EMD pursuant to clause 16 of ITB / invocation of action as per Bid Security declaration and rejection of Bid.

- 24.4 The latest Bid submitted by the Bidder before Bid Due Date & Time shall be considered for evaluation and all other Bid(s) shall be considered to be unconditionally withdrawn.

## **[E] – BID OPENING AND EVALUATION**

### **25. PURCHASER'S RIGHT TO ACCEPT ANY BID AND TO REJECT ANY OR ALL BIDS:**

- 25.1 IGGL reserves the right to accept or reject any Bid, and to annul the Bidding process and reject all Bids, at any time prior to award of Contract, without thereby incurring any liability to the affected Bidder (s) or any obligations to inform the affected Bidder (s) of the ground for IGGL's action. However, Bidder if so desire may seek the reason (in writing) for rejection of their Bid to which IGGL shall respond quickly.
- 25.2 A bidder is to be permitted to send his representation in writing to dealing officer specified in tender for rejection of bid. But such representation has to be sent upto 10(ten) days from the date of Notification of Award/FOA. A decision on representation will be taken by IGGL within 15 (fifteen) days of the receipt of the representation. Only a directly affected bidder can represent in this regard:
- (a) Only a bidder who has participated in tender can make such representation.
  - (b) In case technical bid has been evaluated before the opening of the financial bid, an application for review in relation to the financial bid may be filed only by a bidder whose technical bid is found to be acceptable.

However, following decisions of IGGL shall not be subject to review:

- a) Determination of the need for procurement;
- b) Selection of the mode of procurement or bidding system;
- c) Choice of selection procedure;
- d) Provisions limiting participation of bidders in the procurement process;
- e) The decision to enter into negotiations with the L1 bidder;
- f) Cancellation of the procurement process except where it is intended to subsequently re-tender the same requirements.
- g) Issues related to ambiguity in contract terms may not be taken up after a contract has been signed, all such issues should be highlighted before consummation of the contract by the vendor/ contractor; and
- h) Complaints against specifications except under the premise that they are either vague or too specific so as to limit competition may be permissible.

=====

## 26. **BID OPENING**

### 26.1 **Unpriced Bid Opening:**

IGGL will open bids, at date, time and location stipulated in the BDS in the presence of Bidders' designated representatives who choose to attend.

### 26.2 **Priced Bid Opening:**

26.2.1 IGGL will open the price bids of those bidders who meet the qualification requirement and whose bids is determined to be technically and commercially responsive. Techno-commercial bid evaluation status will be informed to all bidders (including techno-commercially not qualified Bidders).

26.2.2 The priced bids of those Bidders who were not found to be techno-commercially responsive shall not be opened.

## 27. **CONFIDENTIALITY:**

Information relating to the examination, clarification, evaluation and comparison of Bids, and recommendations for the award of a Contract, shall not be disclosed to Bidder(s) or any other persons not officially concerned with such process until the award to the successful bidder.

## 28. **CONTACTING THE PURCHASER:**

28.1 From the time of bid opening to the time of contract award, no bidder shall contact IGGL on any matter related to the bid, except on request and prior written permission.

28.2 Any effort by the Bidder to influence IGGL in 'Bid Evaluation', 'Bid Comparison', or 'Contract Award' decisions may result in the rejection of the Bidder's Bid and action shall be initiated as per procedure for action in case Corrupt / Fraudulent / Collusive / Coercive practices in this regard apart from forfeiture of EMD/ Bid Security, if any.

## 29. **EXAMINATION OF BIDS AND DETERMINATION OF RESPONSIVENESS:**

29.1 The purchaser's determination of a bid's responsiveness is based on the content of the bid only. Prior to the detailed evaluation of Bids, the Purchaser will determine whether each Bid: -

- (a) Meets the "Bid Evaluation Criteria" of the Tender Document;
- (b) Has been properly signed;
- (c) Is accompanied by the required 'Earnest Money / Bid Security / Bid Security Declaration
- (d) Is substantially responsive to the requirements of the Tender Document; and
- (e) Provides any clarification and/or substantiation that the Purchaser may require to determine responsiveness pursuant to "ITB: Clause-29.2"

29.2 A substantially responsive Bid is one which conforms to all the terms, conditions and specifications of the Tender Documents without any material deviation or reservation or omission; for this purpose purchaser defines the foregoing terms below: -

- a) "Deviation" is departure from the requirement specified in the tender documents.

- =====
- b) "Reservation" is the setting of limiting conditions or withholding from complete acceptance of the requirement in the tender documents.
  - c) "Omission" is the failure to submit part or all of the information or documentation required in the tender document.

29.3 A material deviation, reservation or omission is one that,

- a) If accepted would,
  - i) Affect in any substantial way the scope, quality, or performance of the job as specified in tender document.
  - ii) Limit, in any substantial way, inconsistent with the Tender Document, the Purchaser's rights or the bidder's obligations under the proposed Contract.
- b) If rectified, would unfairly affect the competitive position of other bidders presenting substantially responsive bids.

29.4 The purchaser shall examine all aspects of the bid to confirm that all requirements have been met without any material deviation, reservation or omission.

29.5 Tenders that do not meet the basic requirements specified in the bid documents are to be treated as unresponsive {both during Techno-commercial evaluation and Financial Evaluation in case of Two Bid System) and will be ignored. All tenders received will first be scrutinized to see whether the tenders meet the basic requirements as incorporated in the Bid document and to identify unresponsive tenders, if any. Unresponsive offers may not subsequently be made responsive by correction or withdrawal of the non- conforming stipulation. Some important points on the basis of which a tender may be declared as unresponsive and be ignored during the initial scrutiny are:

- i) The tender is not in the prescribed format or is unsigned or not signed as per the stipulations in the bid document;
- ii) The required EMD has not been provided or exemption from EMD is claimed without acceptable proof of exemption;
- iii) The bidder is not eligible to participate in the bid as per laid down eligibility criteria
- vi) The bid departs from the essential requirements specified in the bidding document (for example, the tenderer has not agreed to give the required contract performance security); or
- vii) Against a schedule in the list of requirements in the tender enquiry, the tenderer has not quoted for the entire requirement as specified in that schedule (example: in a schedule, it has been stipulated that the tenderer will supply the equipment, install and commission it and also train the IGGL's personnel for operating the equipment. The tenderer has, however, quoted only for supply of the equipment).

**30. CORRECTION OF ERRORS: Not Applicable**

=====

**31. CONVERSION TO SINGLE CURRENCY FOR COMPARISON OF BIDS:**

Not Applicable. All bids submitted must be in the currency specified at clause 14 of ITB.

**32. EVALUATION AND COMPARISON OF BIDS**

Bid shall be evaluated as per evaluation criteria mentioned in Section-II of Tender document on lowest bid basis.

In case of a tie at the lowest bid (L1) position between two or more bidders, the order/LOA will be placed on the bidder who has higher/ highest turnover in last audited financial year.

**33. QUANTITY VARIATION**

33.1 Where nature of items is such that the items cannot be supplied in exact quantity of the Purchase Order as in case of cables/ steel/ chemicals etc., quantity tolerance upto  $\pm 5\%$  may be allowed, if there is no specific quantity variation/tolerance criteria in SCC. For such tolerance, separate amendment to Purchase Order would not be necessary.

33.2 The Purchaser reserves the right to delete the requirement of any one or more items of Tender Document without assigning any reason.

33.3 At the time of awarding the contract, the tendered quantity can be increased or decreased by 25 (twenty-five) per cent for ordering, if so warranted without change in quoted prices.

**34. PURCHASE PREFERENCE:**

Purchase preference to Micro & Small Enterprises (MSEs) and Domestically Manufactured Electronic Products / Telecom Products or Policy to Provide Purchase Preference as per Public Procurement (Preference to Make in India), Order 2017 etc. shall be allowed as per Government instructions in vogue, as applicable from time to time.

**[F] – AWARD OF CONTRACT**

**35. AWARD:**

Subject to "ITB: Clause-29.0", IGGL will place order to the successful Bidder whose Bid has been determined to be substantially responsive and has been determined as the lowest provided that bidder, is determined to be qualified to satisfactorily perform the Contract.

**“IGGL intent to place the SAP order/contract directly on the address from where Goods are produced/dispatched OR Services are rendered. In case, bidder wants order/contract at some other address or supply of Goods/Services from multiple locations, bidder is required to provide in their bid, the address on which contract is to be placed”.**

IGGL will place the Purchase Order/Contract directly on the successful bidder from whom the bid has been received & evaluated and will not place order on other entities such as subsidiary, business associate or partner, dealer/distributor etc. of the Bidder.

**36. NOTIFICATION OF AWARD / FAX OF ACCEPTANCE:**

36.1 Prior to the expiry of 'Period of Bid Validity', Notification of Award for acceptance of the Bid will be intimated to the successful Bidder by IGGL either by E - mail /Letter or like means defined as the "Fax of Acceptance (FOA)". The Contract shall enter into force on the date of FOA and the same

=====

shall be binding on IGGL and successful Bidder (i.e., Supplier/Seller). The Notification of Award/FOA will constitute the formation of a Contract. The detailed Purchase Order/Contract shall be issued thereafter incorporating terms & conditions of Tender Document, Corrigendum, Clarification(s), Bid and agreed variation(s)/acceptable deviation(s), if any. IGGL may choose to issue Notification of Award in form of detailed Purchase Order (or) SAP PO, without issuing FOA and in such case the Contract shall enter into force on the date of detailed Purchase Order (or) SAP PO only.

- 36.2 Contract/Delivery/Completion period shall commence from the date of Notification of Award/FOA/SAP PO or as mentioned therein.
- 36.3 Upon the successful Bidder's / Supplier's furnishing of 'Contract Performance Security / Security Deposit', pursuant to "ITB: Clause-38", IGGL will promptly discharge his 'Earnest Money / Bid Security (if applicable)', pursuant to "ITB: Clause-16".
- 36.4 The Order value is subject to Price Reduction Schedule (PRS) clause.

## **37. DISPATCH SCHEDULE**

- 37.1 If Purchase Order issued based on FOT (Free on Truck) / FOR (Free on Rail) project site basis, materials shall be delivered at the destination on freight prepaid & door delivery basis and for the cases where order(s) are finalized on Ex-Works basis the transportation will be arranged by supplier(s) / IGGL on 'freight to pay' basis and the freight will be paid at the destination.

Seller shall submit the following details of goods/cargo within 15 days from Notification of Award to the designated authority as per Purchase Order:

- (i) Shipments Schedule
- (ii) Dimension details of packages
- (iii) Detailed technical write-up along with Catalogue (if applicable)
- (iv) Any other document/details, if mentioned in Purchase Order

- 37.2 The consignment should be handed over to transporter with E-way bill, wherever required as per law/act. In case such e-way bill is required to be issued by IGGL, the concerned designated order issuing authority may be contacted in this regard. It will be the responsibility of the supplier to ensure the compliance of the provisions relating to E-Way bill before dispatch of the consignment and any financial implication arising due to noncompliance in this regard will be to the account of the supplier.
- 37.3 It shall be responsibility of the seller to send intimation immediately on dispatch of the material so that necessary arrangements can be made at site. Delays on account of the same shall solely be attributable to the Supplier.
- 37.4 Wherever, part shipment is allowed (refer BDS), the Supplier is allowed to make part shipment. However, until specified elsewhere in Tender Document, Payment for such part supplied Goods shall be made after supply of complete quantity of respective item.
- 37.5 Wherever the items make a full truck load, the suppliers to dispatch such items in a full truck direct to the consignee on a door delivery basis to the site. In such cases, the supplier to send a consignee

=====

copy of the lorry receipt to the consignee along with the consignment and the consignment shall be booked to IGGL and not "self". The supplier should dispatch the consignments to the designated consignee. All dispatch documents, that is, railway/lorry receipt, goods consignment note, airway bill, invoices, packing list, freight memos, test certificate, and so on, shall be sent to the concerned authority which will arrange to make the payment. If the payment is to be made through the bank, all original documents are to be sent through the designated bank.

Where critical equipment is involved, suitable special instructions will be provided in SCC to the supplier about the mode of transport, loading, avoidance of transshipment and, if necessary, provision of escorts. In case of chemicals, powdery materials, liquid materials, and so on, supplier is to ensure proper packaging to avoid spillage en-route, so as to avoid pollution problems and also to conform to the ISO 14001 standard (wherever applicable).

**38. CONTRACT PERFORMANCE SECURITY / SECURITY DEPOSIT [FOR APPLICABILITY OF THIS CLAUSE, REFER BDS]**

38.1 Within 30 days of the receipt of the notification of award (i.e., either LOA or Fax of Acceptance or SAP PO) from IGGL, the successful bidder shall furnish the Contract Performance Security (CPS) in accordance with of General Conditions of the Contract. The CPS shall be in the form of either Banker’s Cheque or Demand Draft or Insurance Surety Bond or Fixed Deposit Receipt or Bank Guarantee (including e-Bank Guarantee) or Letter of Credit and shall be in the currency of the Contract. However, CPS shall not be applicable in cases wherein the individual order value as specified in Notification of Award is less than INR 5 lakh (exclusive of GST).

**NOTE: THE BANK GUARANTEE ISSUED BY THE BANK MUST BE ROUTED THROUGH SFMS PLATFORM AS PER FOLLOWING DETAILS:**

“BG issuance message (IFN 760 / IFN760COV For issuance of BG and IFN 767 / IFN 767 COV FOR Amendment of BG) is to be transmitted through SFMS to beneficiary’s bank as below:

Name of Bank : Axis Bank  
 Branch : Guwahati  
 Branch Address: Chhibber House, Ground Floor, G.S Road, Guwahati -781005  
 IFSC : UTIB0000140  
 SWIFT Code : AXISINBB140

The issuing bank while issuing/amending the BG, should ensure that the below information is correctly captured in the message i.e., IFN 760 / IFN 760COV / IFN 767/ IFN 767COV:

Field Number	Particulars
7037	IGGL938956645

NOTE: THE BANK GUARANTEE ISSUED BY THE BANK MUST BE ROUTED THROUGH SFMS PLATFORM AS PER FOLLOWING DETAILS:

- (i) IFN 760 / IFN 760COV FOR ISSUANCE OF BANK GUARANTEE

=====

(ii) IFN 767 / IFN 767 COV FOR AMENDMENT OF BANK GUARANTEE

(iii) THE ABOVE MESSAGE / INTIMATION SHALL BE SENT THROUGH SFMS BY THE BG ISSUING BANK TO AXIS BANK, GUWAHATI BRANCH, IFSC CODE – UTIB0000140; BRANCH ADDRESS: Axis Bank, Chhibber House, Ground Floor, G.S Road, Guwahati - 781005

(iv) THE SUPPLIER SHALL SUBMIT TO IGGL THE COPY OF SFMS MESSAGE AS SENT BY THE ISSUING BANK ALONG WITH THE ORIGINAL BANK GUARANTEE

38.2 The contract performance security shall be for an amount as specified in Bidding Data Sheet (BDS) towards faithful performance of the contractual obligations and performance of equipment/material. For the purpose of CPS, Contract/order value shall be exclusive of GST (CGST & SGST/UTGST or IGST).

Bank Guarantee towards CPS shall be from any Indian scheduled bank (excluding Co-operative banks and Regional Rural bank) or a branch of an international bank situated in India and registered with Reserve bank of India as scheduled foreign bank. However, in case of bank guarantees from banks other than the Nationalized Indian banks, the bank must be a commercial bank having net worth in excess of Rs 100 crores and a declaration to this effect should be made by such commercial bank either in the Bank Guarantee itself or separately on its letterhead. This bank guarantee shall be valid for a period of three months beyond the DLP/Warranty specified in Bid Data Sheet.

The Supplier shall submit CPS as per Form F-4 of Tender Document.

38.3 Failure of the successful bidder to comply with the requirements of this article shall constitute sufficient grounds for the annulment of the award and forfeiture of the EMD /action as per declaration for Bid Security.

38.4 Further, Ministry of Finance (MOF) Department of financial service has issued direction for submission of Bank Guarantee through online vide letter ref number F.No.7/112/2011-BOA dated 17th July 2012. The successful bidder can submit CPS online through issuing bank to IGGL directly as per the above direction including its revisions, if any. In such cases confirmation will not be sought from issuing banker by IGGL.

38.5 The successful bidder can also submit the SD/CPBG through online banking transaction i.e. IMPS/NEFT/RTGS/SWIFT etc. For this purpose, the details of IGGL's Bank Account is mentioned in BDS. Further, in case a successful Bidder is willing to furnish SD/CPS through SWIFT, the details may be obtained from Purchase Officer immediately after receipt of FOA.

While remitting such online transaction, the bidder must indicate "Security Deposit/ Contract Performance Security against FOA/DLOA/SAP PO no. \_\_\_\_\_ (contractor/ vendor to specify the FOA/DLOA/SAP PO No.)" under remarks column of such transaction on respective bank portal. The contractor/vendor shall be required to submit the successful transaction details to the dealing officer immediately through email/letter and necessarily within 30 days from the date of Notification of Award (i.e. Fax of Acceptance/LOA/SAP PO whichever is issued first).

38.6 In case of forfeiture of Contract Performance Security/ Security Deposit in terms of GCC, the forfeited amount will be considered inclusive of tax and tax invoice will be issued by IGGL. The

=====

forfeiture amount will be subject to final decision of IGGL based on other terms and conditions of order/ contract.

- 38.7 CPBG/Security Deposit will not be accepted in case the same has reference of 'remitter'/'financer' other than bidder on the afore mentioned financial instrument of CPBG/ Security Deposit submitted by the Supplier.
- 38.8 The first payment to vendor is to be released only after submission of CPS / Security Deposit (SD).
- 38.9 Before the CPS / Security Deposit (SD) is released a "No Claim Certificate" is to be submitted by the supplier/vendor.
- 38.10 **Non submission of Security Deposit (SD) on Time:** In case, IGGL allows additional time for submission of CPBG/SD beyond 30 days, a penal interest of Marginal Cost of Fund based Lending Rate (MCLR) for one year charged by SBI (applicable on due date of submission of CPBG/SD i.e., 30th day after issuance of LOA/FOA/Notification of award) plus 4.0% P.A. (on CPBG/SD amount) shall be charged for delay beyond 30 days i.e. from 31st days after issuance of FOA/LOA/SAP PO.

**39. PROCEDURE FOR ACTION IN CASE CORRUPT/ FRAUDULENT/COLLUSIVE/ COERCIVE PRACTICES:**

- 39.1 Procedure for action in case Corrupt/ Fraudulent/Collusive/Coercive Practices is enclosed at Annexure-IV which shall supersede the Annexure attached with the GCC.
- 39.2 The Fraud Prevention Policy document is available on IGGL's website (<https://iggl.co.in>)
- 39.3 Name and contact details of nodal officer are mentioned in BDS.

**39.4 NON-APPLICABILITY OF ARBITRATION CLAUSE IN CASE OF BANNING OF VENDORS/ SUPPLIERS / CONTRACTORS/BIDDERS/ CONSULTANTS INDULGED IN FRAUDULENT/ COERCIVE PRACTICES:**

Notwithstanding anything contained contrary in GCC or elsewhere in the Purchase Order, in case it is found that the Bidder/Supplier indulged in fraudulent/ coercive practices at the time of bidding, during execution of the contract etc., and/or on other grounds as mentioned in IGGL's "Procedure for action in case Corrupt/Fraudulent/Collusive/Coercive Practices", the Bidder/Supplier shall be banned (in terms of aforesaid procedure) from the date of issuance of such order by Indradhanush Gas Grid Limited (IGGL), to such Bidder/Supplier.

The Bidder/Supplier understands and agrees that in such cases where Bidder/Supplier has been banned (in terms of aforesaid procedure) from the date of issuance of such order by IGGL, such decision of IGGL shall be final and binding on the Bidder/Supplier and the 'Arbitration clause' mentioned in the GCC or elsewhere in the Purchase Order shall not be applicable for any consequential issue /dispute arising in the matter.

**40 PUBLIC PROCUREMENT POLICY FOR MICRO AND SMALL ENTERPRISES:**

- 40.1 Following provision has been incorporated in tender for MSEs, in line with notification of Government of India, vide Gazette of India No. 503 dated 26.03.2012 proclaiming the Public

=====

## Procurement Policy on procurement of goods and services from Micro and Small Enterprises (MSEs)

- i) Issue of tender document to MSEs free of cost
- ii) Exemption to MSEs from payment of EMD/Bid Security.
- iii) In Tender, participating Micro and Small Enterprises quoting price within price band of L1+15% shall also be allowed to supply a portion of requirement by bringing down their prices to L1 price in a situation where L1 price is from someone other than a micro and small enterprises and such micro and small enterprises shall be allowed to supply up to 25% of the total tendered value. In case of more than one such Micro and Small Enterprises, the supply shall be shared proportionately (to tendered quantity). Further, out of above 25%, 4% shall be reserved for MSEs owned by SC/ST entrepreneurs.

Further, 3% shall be reserved for MSEs owned by women within above 25% reservation. The respective quota(s) shall be transferred to other MSEs in case of non-availability of MSEs owned by SC/ST entrepreneurs/ MSEs owned by Women.

The quoted prices against various items shall remain valid in case of splitting of quantities of the items above.

**In case tendered item is non-splittable or non-dividable (specified in Bid Data Sheet), MSE quoting price within price band L1 (other than MSE) + 15%, may be awarded for full/ complete supply of total tendered value subject to matching of L1 price.**

40.2 The MSE(s) owned by SC/ST Entrepreneurs shall mean: -

- a) In case of proprietary MSE, Proprietor(s) shall be SC/ST.
- b) In case of partnership MSE, the SC/ST partners shall be holding at least 51% share in the unit
- c) In case of private Limited Companies, at least 51% share is held by SC/ST. If the MSE is owned by SC/ST Entrepreneurs, the bidder shall furnish appropriate documentary evidence in this regard.

The MSE(s) owned by Women shall mean: -

- a) In case of proprietary MSE, Proprietor(s) shall be Women.
- b) In case of partnership MSE, the Women partners shall be holding at least 51% share in the unit
- c) In case of private Limited Companies, at least 51% share is held by Women. If the MSE is owned by Women Entrepreneurs, the bidder shall furnish appropriate documentary evidence in this regard.

40.3 In case Bidder is a Micro or Small Enterprise, the Bidder shall submit Udyam Registration Certificate for availing benefit under Public Procurement Policy for MSEs-2012.

Vide Gazette notification dated 18.10.2022 of Ministry of MSME, the following is notified:

"In case of an upward change in terms of investment in plant and machinery or equipment or turnover or both, and consequent re-classification, an enterprise shall continue to avail of all nontax

benefits of the category (micro or small or medium) it was in before the re-classification, for a period of three years from the date of such upward change.”

Accordingly, in case of upward change in status, MSE bidder is required to submit the previous certificate also to get the MSE benefit.

**The above documents submitted by the bidder shall be duly certified by the Chartered Accountant (not being an employee or a Director or not having any interest in the bidder's company/firm) and notary public with legible stamp.**

If the bidder does not provide the above confirmation or appropriate document or any evidence, then it will be presumed that they do not qualify for any preference admissible in the Public Procurement Policy (PPP) 2012.

**The Public Procurement Policy for MSEs is meant for procurement of only goods produced & Services rendered by MSEs. The benefit of policy are not extended to the traders/dealers/Distributors/Stockiest/Wholesalers.**

- 40.4 If against an order placed by IGGL, successful bidder(s) (other than Micro/Small Enterprise) is procuring material/services from their sub-vendor who is a Micro or Small Enterprise as per provision mentioned at clause no. 40.3 above with prior consent in writing from IGGL, the details like Name, Registration No., Address, Contact No. details of material & value of procurement made, etc. of such Enterprises shall be furnished by the successful Bidder at the time of submission of invoice/Bill.
- 40.5 Further, MSEs who are availing the benefits of the Public Procurement Policy (PPP) 2012 get themselves registered with MSME Data Bank being operated by NSIC, under SME Division, M/o MSME, in order to create proper data base of MSEs which are making supplies to CPSUs.
- 40.6 NSIC has initiated a scheme of Consortia and Tender Marketing Scheme” under which they are assisting the Micro & Small enterprises to market their products and services through tender participation on behalf of the individual unit or through consortia.

Accordingly, if the MSEs or the consortia, on whose behalf the bid is submitted by NSIC, is meeting the BEC and other terms and conditions of tender their bid will be considered for further evaluation.

Further, in such cases a declaration is to be submitted by MSE/consortia on their letter head (s) that all the terms and conditions of tender document shall be acceptable to them.

## **41 PACKING INSTRUCTIONS**

- 41.1 Packing shall be strong and sturdy such that it can withstand loading/unloading & pushing by mechanical devices. All packaging shall be done in such a manner as to reduce volume and weight as much as possible without jeopardizing the safety of the material. All packing materials shall be new.
- 41.2 Fragile articles should have special packing materials depending on type of materials.
- 41.3 All soft and delicate surfaces on equipment/material should be carefully protected/ painted with suitable coating and wrapped to prevent rusting and damage. All mechanical and electrical

=====
equipment and other heavy articles should be securely fastened to the bottom of the case, to avoid damage.

41.4 Attachments and spare parts of equipment and all small pieces shall be packed separately in wooden cases with adequate protection inside the case and sent along with main equipment. Each item shall be tagged so as to identify it with the main equipment and part number and reference number shall be indicated.

41.5 All protrusions shall be suitably protected, and openings shall be blocked by wooden/steel covers as may be required.

41.6 Detailed case wise packing list in waterproof envelope shall be inserted in each package together with equipment/material. One copy of 'Detailed Packing List' shall be fastened outside of the package in waterproof envelope and covered by metal cover.

41.7 Each package shall be marked on three sides with proper paints/indelible waterproof ink as follows:

PURCHASER:

DESTINATION:

Purchase Order No.....

Net Wt..... Kgs,

Gross Wt..... Kgs.

Dimensions.....X.....X.....CM.

Package No. (Sl. No. of total packages) .....

Seller's Name.....

41.8 Permits are to be obtained separately for entry/use of vehicles/trailers etc. inside the plant.

The following requirements are to be met to obtain vehicle permit: -

- a) Vehicle/Equipment etc. should be brought to site in good conditions.
b) Valid Road Tax Certificate, fitness certificate and insurance policy from Competent Authority
c) Valid operating/driving license of driver/operator
d) Any other requirement mentioned elsewhere in Tender Document

41.9 GREEN PACKAGING:

Green packaging, also known as sustainable packaging makes use of materials and manufacturing methods for the packaging of goods that has a significantly low impact on both energy consumption and the environment thus resulting in improved sustainability.

In order to promote Green Packing, vendors/suppliers may use packaging that are preferably biodegradable. Multilayer packaging may not be used, wherever applicable. While packaging, the following may be preferred:

- (i) Adopt green packaging practices for packaging

- =====
- (ii) Packaging may be recyclable with appropriate recycling labels on packaging or goods. The product may be packaged in material that is recyclable after use and be certified for this.
  - (iii) If plastic packaging is unavoidable, then the packaging shall be reusable plastics or made of recycled material. The packaging should have appropriate recycling label on it.
  - (iv) The paper to be packaged in material that is recyclable/reusable or biodegradable.
  - (v) Alternate packaging materials like aluminium, cardboard, paper, paper board, jute bag etc. may be explored.
  - (vi) Use of reusable containers or packaging to transport products;
  - (vii) Styrofoam, thermocols, thin film plastics, polystyrene etc. may be avoided
  - (viii) Avoid the use of materials toxic to humans or the environment

#### **42 VENDOR PERFORMANCE EVALUATION:**

The procedure for evaluation of performance of Supplier containing provisions for putting a Bidder / Supplier on suspension and/or holiday list (as the case may be) is enclosed as Annexure-V to ITB herewith which shall supersede the Annexure attached with the GCC.

#### **43 MENTIONING OF PAN NO. IN INVOICE/BILL**

As per CBDT Notification No. 95/2015 dated 30.12.2015, mentioning of PAN no. is mandatory for transactions related to procurement of goods / services/ exceeding Rs. 2 Lacs per transaction or as amended from time to time.

Accordingly, Supplier should mention their PAN no. in their invoice/ bill for any transaction exceeding Rs. 2 lakhs. As provided in the notification, in case Supplier do not have PAN no., they have to submit declaration in Form 60 along with invoice/ bill for each transaction.

Payment of Supplier shall be processed only after fulfilment of above requirement.

#### **44. DISPUTE RESOLUTION MECHANISM**

##### **44.1 QUARTERLY CLOSURE OF THE CONTRACT**

During execution of orders, various issues may arise. In order to timely detect and to address the contractual issue (s) during the execution of contracts, IGGL has introduced a mechanism of quarterly closure of the contract, under which all the related issues/disputes will be monitored and addressed on quarterly basis for resolution. Vendor/Supplier/Contractor/Consultant (hereinafter referred 'vendor') should first refer any issues/disputes to the Engineer-in-Charge (EIC) or Officer-

=====

in-Charge (OIC) for contracts and co-operate them for smooth execution of the contract and to timely address the issues, if any. For applicability of 'Quarterly Closure', please refer BDS.

## 44.2 **CONCILIATION AND ARBITRATION**

### **1.0 CONCILIATION**

Indradhanush Gas Grid Limited (IGGL) has framed the Conciliation Rules 2019 in conformity with Part – III of the Arbitration and Conciliation Act 1996 as amended from time to time for speedier, cost effective and amicable settlement of disputes through conciliation. All issue(s)/dispute(s) arising under the Contract, which cannot be mutually resolved within a reasonable time, may be referred for conciliation in accordance with IGGL Conciliation Rules 2019 as amended from time to time. A copy of the said rules have been made available on IGGL's web site i.e. <https://iggl.co.in>. Where invitation for Conciliation has been accepted by the other party, the Parties shall attempt to settle such dispute(s) amicably under Part-III of the Arbitration and Conciliation Act, 1996 and Indradhanush Gas Grid Limited (IGGL) Conciliation Rules, 2019. It would be only after exhausting the option of Conciliation as an Alternate Dispute Resolution Mechanism that the Parties hereto shall invoke Arbitration Clause. For the purpose of this clause, the option of 'Conciliation' shall be deemed to have been exhausted, even in case of rejection of 'Conciliation' by any of the Parties.

### **2.0 ARBITRATION**

All issue(s)/dispute(s) excluding the matters that have been specified as excepted matters and listed at clause no. 2.6 and which cannot be resolved through Conciliation, such issue(s)/dispute(s) shall be referred to arbitration for adjudication by Sole Arbitrator.

The party invoking the Arbitration shall have the option to either opt for Ad-hoc Arbitration as provided at Clause 2.1 below or Institutionalized Arbitration as provided at Clause no. 2.2 below, the remaining clauses from 2.3 to 2.7 shall apply to both Ad-hoc and Institutional Arbitration: -

- 2.1 On invocation of the Arbitration clause by either party, IGGL shall suggest a panel of three independent and distinguished persons (Retd Supreme Court & High Court Judges only) to the other party to select any one among them to act as the Sole Arbitrator. In the event of failure of the other party to select the Sole Arbitrator within 30 days from the receipt of the communication from IGGL suggesting the panel of arbitrators, the right of selection of the sole arbitrator by the other party shall stand forfeited and IGGL shall appoint the Sole Arbitrator from the suggested panel of three Arbitrators for adjudication of dispute(s). The decision of IGGL on the appointment of the sole arbitrator shall be final and binding on the other party. The fees payable to Sole Arbitrator shall be governed by the fee Schedule of "Delhi International Arbitration Centre'.

**OR**

- 2.2 If a dispute arises out of or in connection with this contract, the party invoking the Arbitration shall submit that dispute to any one of the Arbitral Institutions i.e., ICADR/ICA/DIAC/SFCA and that dispute shall be adjudicated in accordance with their respective Arbitration Rules. The matter shall be adjudicated by a Sole Arbitrator who shall necessarily be a Retd Supreme Court/High Court Judge to be appointed/nominated by the respective institution. The cost/expenses pertaining to the said Arbitration shall also be governed in accordance with the Rules of the respective Arbitral Institution. The decision of the party invoking the Arbitration for reference of dispute to a specific Arbitral institution for adjudication of that dispute shall

=====

be final and binding on both the parties and shall not be subject to any change thereafter. The institution once selected at the time of invocation of dispute shall remain unchanged.

- 2.3 The cost of arbitration proceedings shall be shared equally by the parties.
- 2.4 The Arbitration proceedings shall be in English language and the seat, venue and place of Arbitration shall be Guwahati, Assam, India only.
- 2.5 Subject to the above, the provisions of Arbitration & Conciliation Act 1996 and any amendment thereof shall be applicable. All matter relating to this Contract and arising out of invocation of Arbitration clause are subject to the exclusive jurisdiction of the Court(s) situated at **Guwahati, Assam, India**.
- 2.6 List of Excepted matters:
- a) Dispute(s)/issue(s) involving claims below Rs 25 lakhs and above Rs 10 crores.
  - b) Dispute(s) / issue(s) relating to indulgence of Contractor / Vendor / Bidder in corrupt / fraudulent / collusive / coercive practices and/or the same is under investigation by CBI or Vigilance or any other investigating agency or Government.
  - c) Dispute(s) / issue(s) wherein the decision of Engineer-In-Charge / owner / IGGL has been made final and binding in terms of the Contract.
- 2.7 Disputes involving claims below Rs 25 Lakhs and above Rs. 10 crores: - Parties mutually agree that dispute(s)/issue(s) involving claims below Rs 25 Lakhs and above Rs 10 crores shall not be subject matter of Arbitration and are subject to the exclusive jurisdiction of the Court(s) situated at **Guwahati, Assam, India**.

**3.0 GOVERNING LAW AND JURISDICTION:** The Contract shall be governed by and construed in accordance with the laws in force in India. The Parties hereby submit to the exclusive jurisdiction of the Courts situated at **Guwahati, Assam, India** for adjudication of disputes, injunctive reliefs, actions and proceedings, if any, arising out of this Contract.

#### **45. DISPUTES BETWEEN CPSE'S/GOVERNMENT DEPARTMENT'S/ ORGANIZATIONS**

Subject to conciliation as provided above, in the event of any dispute (other than those related to taxation matters) or difference relating to the interpretation and application of the provisions of commercial contract(s) between Central Public Sector Enterprises (CPSEs/ Port Trusts) inter se and also between CPSEs and Government Departments /Organizations), such dispute or difference shall be taken up by either party for resolution only through AMRCD as mentioned in OPE OM No. 4(1)/2013-DPE(GM)/FTS-1835 dated 22-05-2018.

Any party aggrieved with the decision of the Committee at the First level (tier) may prefer an appeal before the Cabinet Secretary at the Second level (tier) within 15 days from the date of receipt of decision of the Committee at First level, through it's administrative Ministry/Department, whose decision will be final and binding on all concerned.

The above provisions mentioned at clause no.44 & 45 shall supersede provisions relating to Conciliation, Arbitration, Governing Law & Jurisdiction and Disputes between CPSE's/ Government

=====  
Department's/ Organizations mentioned in General Conditions of Contract (GCC) and elsewhere in tender document.

**46. REPEAT ORDER**

Shall be as per clause no. 40 of GCC-Goods

**47. PROMOTION OF PAYMENT THROUGH CARDS AND DIGITAL MEANS:**

To promote cashless transactions, the onward payments by Suppliers to their employees, service providers, sub-contractors and suppliers may be made through Cards and Digital means to the extent possible.

**48. PROVISIONS FOR START-UP's (AS DEFINED IN GAZETTE NOTIFICATION NO. D.L-33004/99 DATED 18.02.2016 AND 23.05.2017 OF MINISTRY OF COMMERCE AND INDUSTRY AND AS AMENDED FROM TIME TO TIME)**

As mentioned in Section-II, Prior turnover and prior experience shall not be required for all Startups [whether Micro & Small Enterprises (MSEs) or otherwise] subject to their meeting the quality and technical specifications specified in tender document and submission of document specified in Section -II.

Further, the Startups are also exempted from submission of EMDs (if applicable).

If a Startup [whether Micro & Small Enterprises (MSEs) or otherwise] gets qualified without turnover and experience criteria specified in tender and emerges lowest bidder, the order on such Startup shall be placed for entire tendered quantity.

However, before supplying the total quantity, the startup enterprise shall first demonstrate its performance by supplying 10% of total ordered quantity (rounded off to the next higher digit in terms of Unit of Measurement (UoM), wherever required) and only after successful execution of this quantity the balance 90% quantity will be cleared for supply. In case, the demonstration of performance fails; the entire order will be cancelled without any financial implication on either side.

**49. PROVISION REGARDING INVOICE FOR REDUCED VALUE OR CREDIT NOTE TOWARDS PRS**

PRS is the reduction in the consideration / contract value for the goods / services covered under this contract. In case of delay in supply / execution of contract, supplier should raise invoice for reduced value as per Price Reduction Schedule Clause (PRS clause). If supplier has raised the invoice for full value, then service provider should issue Credit Note towards the applicable PRS amount with applicable taxes.

In such cases if supplier fails to submit the invoice with reduced value or does not issue credit note as mentioned above, IGGL will release the payment to supplier after giving effect of the PRS clause with corresponding reduction of taxes charged on vendor's invoice, to avoid delay in delivery / collection of material.

In case any financial implication arises on IGGL due to issuance of invoice without reduction in price or non-issuance of Credit Note, the same shall be to the account of supplier. IGGL shall be entitled to deduct / setoff / recover such GST amount (CGST & SGST/UTGST or IGST) together with penalties and interest, if any, against any amounts paid or becomes payable by IGGL in future to the supplier under this contract or under any other contract.

=====

**50. UNIQUE DOCUMENT IDENTIFICATION NUMBER BY PRACTICING CHARTERED ACCOUNTANTS**

Practicing Chartered Accountants shall generate Unique Document Identification Number (UDIN) for all certificates issued by them as per provisions of Tender Document. However, UDIN may not be required for documents being attested by Chartered Accountants in terms of provisions of Tender Document.

**51. PROVISION W.R.T. TDS ON PURCHASE OF GOODS UNDER SECTION 194Q OF INCOME TAX ACT:**

51.1 TDS as applicable will be deducted by IGGL under section 194Q of the Income Tax Act, 1961 on Purchases exceeds Rs. 50 Lakhs or limit defined therein from time to time during the financial year.

51.2 Since IGGL is liable to deduct Income Tax TDS under section 194Q, the provision of TCS as per section 206 (1H) of the Income Tax Act, 1961 shall not be applicable.

51.3 Higher rate of TDS for non-filers of ITR

As per Section 206AB of Income Tax Act, 1961, in case of any vendor/supplier who does not filed their Income Tax Return for both of the two previous years preceding to current year and aggregate amount of TDS is more than or equal to 50,000/- in each of those previous two years (or limit defined by Govt. from time to time), then TDS will be deducted at the higher of following rates:

- (i) Twice the rate mentioned in relevant TDS section.
- (ii) Twice the rate or rates in force.
- (iii) 5%.

**52. DOCUMENTS FOR PAYMENT:**

Payment terms shall be as mentioned in GCC-Goods / SCC.

However, for release of payment, the following documents is to be submitted by supplier / vendor:

- (i) Supplier's Invoice indicating, inter alia description and specification of the goods, quantity, unit price, total value;
- (ii) Packing list;
- (iii) LR/GR/consignment note;
- (iv) Manufacturer's guarantee certificate and in-house inspection certificate (wherever applicable);
- (v) Inspection certificate issued by purchaser's inspector (wherever applicable); and
- (vi) Any other document(s) as and if required in terms of the contract.

Further, IGGL has implemented Bill Tracking System (BTS). Supplier/Vendor must forward their invoice through BTS (<https://vendor.iggl.co.in/>) by uploading a digital copy of the invoice in the portal. However, the hard copy of invoice and all other document mentioned above or in order/contract is to be forwarded to address provided in order/contract. The concerned Engineer-in-Charge or Officer-in-Charge may be contacted for further guidance.

**53. RESTRICTING PARTICIPATION OF NCLT REFERRED BIDDERS**

- (i) Offer from the following type of bidders/members of consortium will not be considered:

- =====
- a) Bidders who are undergoing insolvency resolution process or liquidation or bankruptcy proceeding under Insolvency and Bankruptcy Code, 2016 (Code).
  - b) Bidders whose resolution process or liquidation or bankruptcy proceeding is initiated under the Code at any stage of evaluation of bid.
- (ii) It will be responsibility of the bidder/contractor/vendor to inform IGGL within 15 (Fifteen) days from the date of order of insolvency resolution process or liquidation or bankruptcy proceeding passed by the Adjudicating Authority namely National Company Law Tribunal (NCLT) or Debt Recovery Tribunal (DRT) under the Code.
- (iii) If bidder fails to share the information regarding their status of insolvency resolution process or liquidation or bankruptcy proceeding in their bid or at any latter stage, their offer is liable to be rejected by IGGL.
- (iv) IGGL reserve the right to cancel / terminate the contract without any liability on the part of IGGL immediately on the commencement of insolvency resolution process or liquidation or bankruptcy proceeding of any party under the contract.
- A **declaration in this regard** shall be furnished by the bidder as per proforma enclosed as Form-15 (F-15) in Section-V of this tender.

=====

**Annexure-I to Section-III**

**ADDENDUM TO INSTRUCTIONS TO BIDDERS**  
**(INSTRUCTIONS FOR PARTICIPATION IN TENDER)**

**Available on Govt. CPP Portal- <https://etenders.gov.in/eprocure/app>**

<https://etenders.gov.in/eprocure/app?page=BiddersManualKit&service=page>

=====

**Annexure-II to Section-III**

**BIDDING DATA SHEET (BDS)**

**ITB TO BE READ IN CONJUNCTION WITH THE FOLLOWING:**

A. GENERAL					
ITB clause	Description				
1.1	The Purchaser/Employer/Owner is: IGGL				
1.2	The Invitation for Bids/ Tender no is: IGGL/GHY/C&P/PROJ/BALL-VALVE/04-26				
3	<p>BIDS FROM CONSORTIUM/ JOINT VENTURE</p> <table border="1"> <tr> <td>APPLICABLE</td> <td><input type="checkbox"/></td> </tr> <tr> <td>NOT APPLICABLE</td> <td><input checked="" type="checkbox"/></td> </tr> </table>	APPLICABLE	<input type="checkbox"/>	NOT APPLICABLE	<input checked="" type="checkbox"/>
APPLICABLE	<input type="checkbox"/>				
NOT APPLICABLE	<input checked="" type="checkbox"/>				
B. TENDER DOCUMENT					
ITB clause	Description				
8.1	<p>For <b>clarification purposes</b> only, the communication address is:                      Attention: <u>Kulajit Talukdar, General Manager (C&amp;P), Indradhanush Gas Grid Ltd.</u>                      Street Address: <u>Christian Basti, G.S Road</u>                      Floor/Room number: <u>7th Floor, 122A, NRL Centre.</u>                      City: <u>Guwahati</u>                      PIN Code: <u>781005</u>                      Country: <u>India</u>                      Email: <a href="mailto:kulajit.talukdar@iggl.co.in">kulajit.talukdar@iggl.co.in</a></p>				
C. PREPARATION OF BID					
ITB clause	Description				
11.1.1	<p>Additional documents to be submitted by the Bidder with its Part-I (Techno-commercial/ Unpriced bid): SCC/Scope of Work refers.</p> <p>- As per Bid Evaluation Criteria (BEC) section-II of this tender.</p>				
12 & 13	<p>Whether IGGL will be able to avail input tax credit in the instant tender</p> <table border="1"> <tr> <td>YES</td> <td><input type="checkbox"/></td> </tr> <tr> <td>NO</td> <td><input checked="" type="checkbox"/></td> </tr> </table>	YES	<input type="checkbox"/>	NO	<input checked="" type="checkbox"/>
YES	<input type="checkbox"/>				
NO	<input checked="" type="checkbox"/>				

<b>13.8</b>	<p>Details of Buyer:</p> <table border="1" style="width: 100%;"> <tr> <td style="width: 20%;">Consignee</td> <td>Indradhanush Gas Grid Limited 7<sup>th</sup> Floor, 122A, NRL Centre, Christian Basti, G. S. Road, Guwahati, Assam-781005</td> </tr> <tr> <td>PAN No.</td> <td>AAECI9589F</td> </tr> <tr> <td>GST no.</td> <td>18AAECI9589F1ZZ</td> </tr> <tr> <td>IGGL Bank details</td> <td> <p><b>Account holder's name:</b> INDRADHANUSH GAS GRID LIMITED</p> <p><b>Bank Name:</b> State Bank of India  <b>Account No.:</b> Current A/C No. 37967639273  <b>IFSC Code:</b> SBIN0003030  <b>BRANCH:</b> Dispur Branch, Guwahati, ASSAM-781006</p> </td> </tr> </table>	Consignee	Indradhanush Gas Grid Limited 7 <sup>th</sup> Floor, 122A, NRL Centre, Christian Basti, G. S. Road, Guwahati, Assam-781005	PAN No.	AAECI9589F	GST no.	18AAECI9589F1ZZ	IGGL Bank details	<p><b>Account holder's name:</b> INDRADHANUSH GAS GRID LIMITED</p> <p><b>Bank Name:</b> State Bank of India  <b>Account No.:</b> Current A/C No. 37967639273  <b>IFSC Code:</b> SBIN0003030  <b>BRANCH:</b> Dispur Branch, Guwahati, ASSAM-781006</p>
Consignee	Indradhanush Gas Grid Limited 7 <sup>th</sup> Floor, 122A, NRL Centre, Christian Basti, G. S. Road, Guwahati, Assam-781005								
PAN No.	AAECI9589F								
GST no.	18AAECI9589F1ZZ								
IGGL Bank details	<p><b>Account holder's name:</b> INDRADHANUSH GAS GRID LIMITED</p> <p><b>Bank Name:</b> State Bank of India  <b>Account No.:</b> Current A/C No. 37967639273  <b>IFSC Code:</b> SBIN0003030  <b>BRANCH:</b> Dispur Branch, Guwahati, ASSAM-781006</p>								
<b>14</b>	The currency of the Bid shall be <b>INR</b>								
<b>15</b>	The bid validity period shall be <b>03 (Three) Months</b> from final 'Bid Due Date'								
<b>16.1, 16.2 and 38.5</b>	<p>In case '<b>Earnest Money / Bid Security</b>' or "<b>Contract Performance Security</b>" is in the form of '<b>Demand Draft</b>' or '<b>Banker's Cheque</b>' or '<b>Insurance Surety Bond</b>' or '<b>Fixed Deposit Receipt</b>', the same should be in favour of <b>Indradhanush Gas Grid Limited</b> payable at <b>GUWAHATI</b>.</p> <p>In case of submission through online banking transaction i.e., IMPS / NEFT / RTGS / SWIFT, etc, the details of IGGL's Bank account are as under:</p> <p><b>Account Holder's Name:</b> INDRADHANUSH GAS GRID LIMITED  <b>Account Number:</b> Current A/C No. 37967639273  <b>IFSC Code:</b> SBIN0003030  <b>BRANCH:</b> Dispur Branch, Guwahati, ASSAM-781006</p> <p><b><u>Bidder to mention reference no. "EMD/....." in narration while remitting the EMD / Bid Security amount and to mention reference no. "CPS/....." in narration while remitting the CPS amount in IGGL's Bank Account.</u></b></p>								
<b>D. SUBMISSION AND OPENING OF BIDS</b>									
<b>ITB clause</b>	<b>Description</b>								
<b>22</b>	The E-Tender No. of this bidding process is: IGGL-100110								

<b>4.0 of IFB</b>	For submission of physical document as per clause no. 4.0 of IFB, the Owner's address is: Attention: <u>Kulajit Talukdar, General Manager (C&amp;P), Indradhanush Gas Grid Ltd.</u> Street Address: <u>Christian Basti, G.S Road</u> Floor/Room number: <u>7th Floor, 122A, NRL Centre,</u> City: <u>Guwahati</u> PIN Code: <u>781005</u> Country: <u>India</u>				
<b>E. EVALUATION, AND COMPARISON OF BIDS</b>					
<b>ITB clause</b>	<b>Description</b>				
<b>32</b>	Evaluation Methodology is mentioned in Section-II.				
<b>34</b>	The following Purchase Preference Policy will be applicable as per provisions mentioned in tender: (i) Micro & Small Enterprises (MSEs)				
<b>F. AWARD OF CONTRACT</b>					
<b>ITB clause</b>	<b>Description</b>				
<b>36</b>	The following designated authority shall be contacted after receipt of Notification of Award for all contractual matters: "Will be mentioned in the Notification of Award"				
<b>38</b>	Contract Performance Security / Security Deposit <table border="1" style="margin-left: auto; margin-right: auto;"><tr><td style="text-align: center;">APPLICABLE</td><td style="text-align: center;"><input checked="" type="checkbox"/></td></tr><tr><td style="text-align: center;">NOT APPLICABLE</td><td style="text-align: center;"><input type="checkbox"/></td></tr></table> <b>The value/ amount of Contract Performance Security/ Security Deposit:</b> <b>CPS/SD @ 5% of Total Order / Contract value excluding GST.</b> (Refer ITB Clause 38 for more details)	APPLICABLE	<input checked="" type="checkbox"/>	NOT APPLICABLE	<input type="checkbox"/>
APPLICABLE	<input checked="" type="checkbox"/>				
NOT APPLICABLE	<input type="checkbox"/>				
<b>39.3</b>	Name and contact details of nodal officer are as under: <b>Shri Kulajit Talukdar, General Manager (C&amp;P)</b> Tel: 9531101226/8 Email: <a href="mailto:kulajit.talukdar@iggl.co.in">kulajit.talukdar@iggl.co.in</a>				

<p><b>40</b></p>	<p>Whether tendered item is non-splitable or not-divisible:</p> <table border="1" data-bbox="414 309 1077 459"> <tr> <td data-bbox="414 309 753 380">YES</td> <td data-bbox="753 309 1077 380"><input checked="" type="checkbox"/></td> </tr> <tr> <td data-bbox="414 380 753 459">NO</td> <td data-bbox="753 380 1077 459"><input type="checkbox"/></td> </tr> </table> <p>As tendered items are non-splitable or non- dividable, MSE quoting price within price band L1 (other than MSE) + 15%, will be awarded for full/ complete supply of total tendered value subject to matching of L1 price.</p> <p>However, the benefit of policy will not be extended to the traders / dealers / Distributors / Stockiest / Wholesalers.</p>	YES	<input checked="" type="checkbox"/>	NO	<input type="checkbox"/>
YES	<input checked="" type="checkbox"/>				
NO	<input type="checkbox"/>				
<p><b>44.1</b></p>	<p>Quarterly Closure of Contract</p> <table border="1" data-bbox="414 779 1069 985"> <tr> <td data-bbox="414 779 750 891">APPLICABLE</td> <td data-bbox="750 779 1069 891"><input type="checkbox"/></td> </tr> <tr> <td data-bbox="414 891 750 985">NOT APPLICABLE</td> <td data-bbox="750 891 1069 985"><input checked="" type="checkbox"/></td> </tr> </table>	APPLICABLE	<input type="checkbox"/>	NOT APPLICABLE	<input checked="" type="checkbox"/>
APPLICABLE	<input type="checkbox"/>				
NOT APPLICABLE	<input checked="" type="checkbox"/>				
<p><b>48</b></p>	<p>Applicability of provisions relating to Start-ups:</p> <table border="1" data-bbox="414 1104 1077 1272"> <tr> <td data-bbox="414 1104 753 1198">APPLICABLE</td> <td data-bbox="753 1104 1077 1198"><input type="checkbox"/></td> </tr> <tr> <td data-bbox="414 1198 753 1272">NOT APPLICABLE</td> <td data-bbox="753 1198 1077 1272"><input checked="" type="checkbox"/></td> </tr> </table>	APPLICABLE	<input type="checkbox"/>	NOT APPLICABLE	<input checked="" type="checkbox"/>
APPLICABLE	<input type="checkbox"/>				
NOT APPLICABLE	<input checked="" type="checkbox"/>				
<p><b>Clause no. 38 of GCC</b></p>	<p>Fall Clause:</p> <table border="1" data-bbox="414 1388 1077 1579"> <tr> <td data-bbox="414 1388 753 1482">APPLICABLE</td> <td data-bbox="753 1388 1077 1482"><input type="checkbox"/></td> </tr> <tr> <td data-bbox="414 1482 753 1579">NOT APPLICABLE</td> <td data-bbox="753 1482 1077 1579"><input checked="" type="checkbox"/></td> </tr> </table>	APPLICABLE	<input type="checkbox"/>	NOT APPLICABLE	<input checked="" type="checkbox"/>
APPLICABLE	<input type="checkbox"/>				
NOT APPLICABLE	<input checked="" type="checkbox"/>				
<p><b>40</b></p>	<p>Applicability of provisions relating to MSE:</p> <table border="1" data-bbox="414 1686 1088 1854"> <tr> <td data-bbox="414 1686 753 1780">APPLICABLE</td> <td data-bbox="753 1686 1088 1780"><input checked="" type="checkbox"/></td> </tr> <tr> <td data-bbox="414 1780 753 1854">NOT APPLICABLE</td> <td data-bbox="753 1780 1088 1854"><input type="checkbox"/></td> </tr> </table>	APPLICABLE	<input checked="" type="checkbox"/>	NOT APPLICABLE	<input type="checkbox"/>
APPLICABLE	<input checked="" type="checkbox"/>				
NOT APPLICABLE	<input type="checkbox"/>				

---

<b>34</b>	Applicability of provisions relating to PPP-MII:	
	APPLICABLE	<input type="checkbox"/>
	NOT APPLICABLE	<input checked="" type="checkbox"/>

=====

## ANNEXURE-III TO SECTION-III

### **POLICY TO PROVIDE PURCHASE PREFERENCE AS PER PUBLIC PROCUREMENT (PREFERENCE TO MAKE IN INDIA), ORDER 2017- (Not applicable for this tender)**

- 1.0 Ministry of Petroleum & Natural Gas vide Notification No. FP-20013/2/2017-FP-PNG-Part(4) (E-41432) dated 26.04.2022 has notified that Public Procurement (Preference to Make in India), Order 2017 (PPP-MII) issued by DPIIT and as amended from time to time shall be applicable to all the Public Sector Undertakings and their wholly owned subsidiaries under MoP&NG with certain modifications.
- 2.0 The Public Procurement (Preference to Make in India), Order 2017 (PPP-MII) issued by DPIIT to encourage 'Make in India' and promote manufacturing & production of goods and services in India with a view to enhancing income and employment.
- 3.0 **DEFINITIONS: -**
- (i) **Local Content** means the amount of value added in India which shall, unless otherwise prescribed by the Nodal Ministry, be the total value of item procured (excluding net domestic indirect taxes) minus the value of imported content in the item (including all custom duties) as a proportion of the total value, in percent.  
Further Local value addition through services such as transportation, insurance, installation, commissioning, training, and after sale support like AMC/CMC etc. shall be considered in local content calculation.
- (ii) **'Class-I local supplier'** means a supplier or service provider, whose goods, services or works offered for procurement, meets the minimum local content of equal to or more than 50%.
- 'Class-II local supplier'** means a supplier or service provider, whose goods, services or works offered for procurement, meets the minimum local content of more than 20% but less than 50%.
- 'Non-Local supplier'** means a supplier or service provider, whose goods, services or works offered for procurement, has local content less than or equal to 20%.
- (iii) **L1** mean the lowest tender or lowest bid or the lowest quotation received in a tender, bidding process or other procurement solicitation as adjudged in the evaluation process as per tender or other procurement solicitation.
- (iv) **Margin of Purchase Preference:** means the maximum extent to which the price quoted by a Class-I local supplier may be above the L1 for purpose of purchase Preference.
- (v) **Nodal Ministry** means the Ministry of Petroleum & Natural Gas.
- (vi) **Procuring Entity** means Indradhanush Gas Grid Limited (IGGL).
- (vii) **Works** means all the works as per Rule 130 of GFR-2017 also include 'turnkey-works'.
- 4.0 **Margin of Purchase Preference:** The margin of purchase preference shall be 20%.

=====

5.0 **ELIGIBILITY OF 'CLASS-I LOCAL SUPPLIER'/ 'CLASS-II LOCAL SUPPLIER'/ 'NON LOCAL SUPPLIERS' FOR DIFFERENT TYPES OF PROCUREMENT**

- (a) In procurement of all goods, services or works in respect of which the Nodal Ministry / Department has communicated that there is sufficient local capacity and local competition, only 'Class-I local supplier', shall be eligible to bid irrespective of purchase value.
- (b) Only 'Class-I local supplier' and 'Class-II local supplier', shall be eligible to bid in procurements undertaken by procuring entities, except when Global tender enquiry/ International Competitive bidding has been issued. In global tender enquiries/ International Competitive bidding 'Non-local suppliers' shall also be eligible to bid along with 'Class-I local suppliers' and 'Class-II local suppliers'.
- (c) Works includes Engineering, Procurement and Construction (EPC) contracts and services include System Integrator (SI) contracts
- (d) HP-HT Operations in upstream oil and gas business activities shall be exempted from this order

6.0 **PURCHASE PREFERENCE METHODOLOGY UNDER PPP-MII (SUBJECT TO QUANTITY DISTRIBUTION APPLICABLE TO MSES AS PER PUBLIC PROCUREMENT POLICY FOR MSE 2012, REFER EXAMPLES GIVEN BELOW):**

- (a) Purchase preference shall be given to 'Class-I local supplier' in procurements in the manner specified here under.
- (b) In the procurements of goods or works which are covered by para 5 (b) above and which are divisible in nature, the 'Class-I local supplier' shall get purchase preference over 'Class-II local supplier' as well as 'Non-local supplier', as per following procedure:
  - i. Among all qualified bids, the lowest bid will be termed as L1. If L1 is 'Class-I local supplier', the contract for full quantity will be awarded to L1.
  - ii. If L1 bid is not a 'Class-I local supplier', 50% of the order quantity shall be awarded to L1. Thereafter, the lowest bidder among the 'Class-I local supplier' will be invited to match the L1 price for the remaining 50% quantity subject to the Class-I local supplier's quoted price falling within the margin of purchase preference, and contract for that quantity shall be awarded to such 'Class-I local supplier' subject to matching the L1 price. In case such lowest eligible 'Class-I local supplier' fails to match the L1 price or accepts less than the offered quantity, the next higher 'Class-I local supplier' within the margin of purchase preference shall be invited to match the L1 price for remaining quantity and so on, and contract shall be awarded accordingly. In case some quantity is still left uncovered on Class-I local suppliers, then such balance quantity may also be ordered on the L1 bidder.
- (c) In the procurements of goods or works which are covered by para 5 (b) and which are not divisible in nature, and in procurement of services where the bid is evaluated on price alone, the 'Class-I local supplier' shall get purchase preference over 'Class-II local supplier' as well as 'Non-local supplier', as per following procedure.

=====

- i. Among all qualified bids, the lowest bid will be termed as L1. If L1 is 'Class-I local supplier', the contract will be awarded to L1.
  - ii. If L1 is not 'Class-I local supplier', the lowest bidder among the 'Class-I local supplier', will be invited to match the L1 price subject to Class-I local supplier's quoted price falling within the margin of purchase preference, and the contract shall be awarded to such 'Class-I local supplier' subject to matching the L1 price.
  - iii. In case such lowest eligible 'Class-I local supplier' fails to match the L1 price, the 'Class-I local supplier' with the next higher bid within the margin of purchase preference shall be invited to match the L1 price and so on and contract shall be awarded accordingly. In case none of the 'Class-I local supplier' within the margin of purchase preference matches the L1 price, the contract may be awarded to the L1 bidder.
  - iv. "Class-II local supplier" will not get purchase preference in any procurement.
- d) **Applicability in tenders where contract is to be awarded to multiple bidders** - In tenders where contract is awarded to multiple bidders subject to matching of L1 rates or otherwise which are covered by para 5 (b), the 'Class- I local supplier' shall get purchase preference over 'Class II-local supplier' as well as 'Non-local supplier', as per following procedure:
- i) If 'Class-I Local suppliers' qualify for award of contract for at least 50% of the tendered quantity in any tender, the contract may be awarded to all the qualified bidders as per award criteria stipulated in the bid documents. However, in case 'Class -I Local suppliers' do not qualify for award of contract for at least 50% of the tendered quantity, purchase preference should be given to the 'Class-I local supplier' over 'Class-II local suppliers'/ 'Non local suppliers' provided that their quoted rate falls within 20% margin of purchase preference of the highest quoted bidder considered for award of contract so as to ensure that the 'Class-I Local suppliers' taken in totality are considered for award of contract for at least 50% of the tendered quantity.
  - ii) First purchase preference has to be given to the lowest quoting 'Class-I local supplier', whose quoted rates fall within 20% margin of purchase preference, subject to its meeting the prescribed criteria for award of contract as also the constraint of maximum quantity that can be sourced from any single supplier. If the lowest quoting 'Class-I local supplier', does not qualify for purchase preference because of aforesaid constraints or does not accept the offered quantity, an opportunity may be given to next higher 'Class-I local supplier', falling within 20% margin of purchase preference, and so on.
- 7.0 In case a bidder (Class-I Local supplier) is eligible to seek benefit under Policy for Preference under Public Procurement (Preference to Make in India), Order 2017 as well as Public Procurement Policy for MSE 2012 (PPP for MSE 2012), then the bidder should categorically confirm its option to choose benefits against only one of the two policies i.e. either PPP-MII and MSE policy in Form-1. The option once exercised cannot be modified subsequently.

=====

Purchase preference benefits shall be extended to the bidder based on the declared option subject to the bidder meeting the requirements contained in that purchase preference policy.

In case a MSEs bidder opts for purchase preference based on PPP-MII, such bidder shall not be entitled to claim purchase preference benefit available to MSE Bidders under PPP-2012. However, the exemptions from furnishing Bidding Document fee and Bid security/EMD shall continue to be available to such MSE Bidder.

While for evaluating a particular bid that bidder's option (to avail any one out of two applicable purchase preference policies, i.e., PPP-MII or PPP-2012) will be considered, for price matching opportunities and distribution of quantities among bidders, the precedence shall be in the following order: -

- (i) Public Procurement Policy for MSE 2012
- (ii) Public Procurement (Preference to Make in India), Order 2017

## **8.0 Example to deal Various situations in case a bidder is eligible to seek benefit under Public Procurement (Preference to Make in India), Order 2017 as well as Public Procurement Policy for MSE 2012 (PPP for MSE 2012):**

### **(I) Non divisible item**

L1 bidder is non MSE, Non-Local supplier/ Class-II local supplier as per PPP-MII  
L2 bidder is Class-I Local supplier as per PPP-MII (prices within 20%)  
L3 bidder is MSE bidder (prices within 15%)

MSE bidder shall be given preference to match the L1 price. If bidder matches the L1 price, order shall be placed on him, otherwise, option for matching the L1 price shall be given to L2 bidder (PPP-MII)

### **(II) Divisible item-Case 1**

L1 bidder is non MSE, Non-Local supplier/ Class-II local supplier as per PPP-MII  
L2 bidder is Class-I Local supplier as per PPP-MII (within 20%)  
L3 bidder is MSE bidder (within 15%)

MSE bidder shall be given preference to match the L1 price. If bidder matches the L1 price, order shall be placed on him for the quantity specified in the bidding document for MSEs (i.e. 25% of the tendered quantity). For 50% of tendered quantity option for matching the L1 price shall be given to L2 bidder (Class-I Local supplier as per PPP-MII). Balance quantity (i.e. 25% of the tendered quantity) shall be awarded to original L1 bidder.

### **(III) Divisible item-Case 2**

L1 bidder is non MSE, Non-Local supplier/ Class-II as per PPP-MII  
L2 bidder is Class-I Local supplier as per PPP-MII (within 20%)  
L3 bidder is MSE bidder (within 15%)  
L4 bidder is MSE bidder (within 15%)

=====

MSE bidders shall be given preference to match the L1 price. If bidders matched the L1 price, order shall be placed on each of them for 12.5% of the tendered quantity. In case L3 or L4 bidder refuses, the order shall be placed on remaining MSE bidder who matches the L1 prices for 25% of the quantity. For 50% of tendered quantity option for matching the L1 price shall be given to L2 bidder (Class-I Local supplier as per PPP-MII). Balance quantity (i.e., 25% of the tendered quantity) shall be awarded to original L1 bidder.

(IV) In case L1 bidder is MSE bidder, the entire work shall be awarded to him without resorting to purchase preference to Class-I Local supplier as per PPP- MII.

(V) In case L1 bidder is a Local supplier as per PPP-MII, purchase preference shall be resorted to MSE bidder as per PPP 2012 only.

## 9.0 VERIFICATION OF LOCAL CONTENT/ DOMESTIC VALUE ADDITION

- a. The 'Class-I local supplier'/ 'Class-II local supplier' at the time of tender, bidding or solicitation shall require to indicate percentage of local content and provide **self-certification** (as per proforma at Form-2) that the item offered meets the minimum local content for 'Class-I local supplier'/ 'Class-II local supplier' as the case may be and shall give details of the location(s) at which the local value addition is made.
- b. VOID
- c. In case a complaint is received by the procuring agency relating to implementation of this order including the claim of a bidder regarding local content/ domestic value addition, the same shall be referred to Competent Authority who is empowered to look into procurement related complaints.
- d. Nodal Ministry may constitute committees with internal and external experts for independent verification of self-declarations and auditor's/accountant's certificates on random basis and in the case of complaints. A complaint fee of Rs.2 Lakh or 1% of the value of the domestically manufactured products being procured (subject to a maximum of Rs. 5 Lakh), whichever is higher, shall be paid by Demand Draft to be deposited with IGGL. In case, the complaint is found to be incorrect, the complaint fee shall be forfeited. In case, the complaint is upheld and found to be substantially correct, deposited fee of the complainant would be refunded without any interest.
- e. In case of false declarations, IGGL shall initiate action for banning such manufacturer/supplier/service provider as per as per IGGL's extant "Procedure for action in case Corrupt/Fraudulent/Collusive/Coercive Practices"
- f. A supplier who has been debarred by any procuring entity for violation of this Order shall not be eligible for preference under this Order for procurement by any other procuring entity for the duration of the debarment. The debarment for such other procuring entities shall take effect prospectively from the date on which it comes to the notice of other procurement entities, in the manner prescribed under paragraph g below.
- g. The Department of Expenditure shall issue suitable instructions for the effective and smooth operation of this process, so that:

- =====
- i. The fact and duration of debarment for violation of this Order by any procuring entity are promptly brought to the notice of the Member- Convenor of the Standing Committee and the Department of Expenditure through the concerned Ministry /Department or in someother manner;
  - ii. on a periodical basis such cases are consolidated and a centralized list or decentralized lists of such suppliers with the period of debarment is maintained and displayed on website(s);
  - iii. in respect of procuring entities other than the one which has carried out the debarment, the debarment takes effect prospectively from the date of uploading on the website(s) in such a manner that ongoing procurements are not disrupted.

## **10.0** RECIPROCITY CLAUSE

- i. When a Nodal Ministry/Department identifies that Indian suppliers of an item are not allowed to participate and/ or compete in procurement by any foreign government, due to restrictive tender conditions which have direct or indirect effect of barring Indian companies such as registration in the procuring country, execution of projects of specific value in the procuring country etc., it shall provide such details to all its procuring entities including CMDs/CEOs of PSEs/PSUs, State Governments and other procurement agencies under their administrative control and GeM for appropriate reciprocal action.
- ii. Entities of countries which have been identified by the nodal Ministry/Department as not allowing Indian companies to participate in their Government procurement for any item related to that nodal Ministry shall not be allowed to participate in Government procurement in India for all items related to that nodal Ministry/ Department, except for the list of items published by the Ministry/ Department permitting their participation.
- iii. The term 'entity' of a country shall have the same meaning as under the FDI Policy of DPIIT as amended from time to time.

=====
FORM-1 TO ANNEXURE-III TO SECTION-III

**UNDERTAKING FOR APPLICABILITY OF POLICY (APPLICABLE FOR MSEs and CLASS-I LOCAL SUPPLIER ONLY)**

To,

M/s INDRADHANUSH GAS GRID LIMITED

7TH Floor, 122A, NRL Centre, Christian Basti, G S Road, Guwahati-781005, Assam

SUB:

TENDER NO:

Dear Sir

We, M/s \_\_\_\_\_ (Name of Bidder) hereby confirm that following purchase preference to be considered: -

Table with 2 columns: Description, Preference. Row 1: Purchase Preference under Public Procurement Policy for MSE, [ ] (checkbox). Row 2: Preference Under Public Procurement (Preference to Make in India), Order 2017 (PPP-MII), [ ] (checkbox).

Note:

- (i) Please indicate your preference against only one policy.
(ii) The above preference shall be extended only after submission of requisite documents (as mentioned in the tender documents).
(iii) In case a bidder is eligible to seek benefit under PPP-MII order as well as PPP for MSE2012, then the bidder should categorically seek benefits against only one of the two policies i.e. either PPP-MII and MSE policy.
(iv) In case a MSEs bidder opts for purchase preference based on PPP-MII order, he shall not be entitled to claim purchase preference benefit available to MSE Bidders under PPP for MSE 2012. However, the exemptions from furnishing Bidding Document fee and Bid security/EMD shall continue to be available to MSE Bidders
(v) The option once exercised cannot be modified subsequently.
(vi) In case MSE bidder is opting the PPP-MII policy and emerges other than L1 bidder, then only Purchase Preference as per PPP-MSE policy is not applicable.

Place:

[Signature of Authorized Signatory of Bidder]

Date:

Name:

Designation:

Seal:

=====
FORM-2 TO ANNEXURE-III TO SECTION-III

**SELF CERTIFICATION BY BIDDER WHO CLASS-I LOCAL SUPPLIER/ CLASS-II LOCAL SUPPLIER TOWARDS MANDATORY MINIMUM LOCAL CONTENT/DOMESTIC VALUE ADDITION**

To,

M/s INDRADHANUSH GAS GRID LIMITED
7th Floor, 122A, NRL Centre, Christian Basti, G S Road, Guwahati-781005, Assam

SUB:

TENDER NO:

Dear Sir

We, M/s \_\_\_\_\_ (Name of Bidder) confirm that as per the definition of policy we are:

Class-I Local supplier [ ]

Class-II Local Supplier [ ]

(Bidder is to tick appropriate option (✓) above).

It is further confirm that M/s \_\_\_\_\_ (Name of Bidder) meet the mandatory minimum Local content/Domestic Value Addition requirement for Class-I Local supplier/ Class-II Localsupplier (as the case may be) under Public Procurement (Preference to Make in India), Order 2017 (PPP-MII) and has value addition of ..... %.

The details of the location (s) at which the local value addition is made is as under:

.....
.....
.....

We further confirm that in case we fail to meet the minimum local content/domestic value addition, the same shall be treated false information and IGGL will take action as per provision of tender document.

Place: [Signature of Authorized Signatory of Bidder]
Date: Name:
Designation:
Seal:



=====
FORM-3 TO ANNEXURE-III TO SECTION-III

**CERTIFICATE BY STATUTORY AUDITOR/COST AUDITOR/ CHARTERED ACCOUNTANT OF BIDDER TOWARDS MANDATORY MINIMUM LOCAL CONTENT/ DOMESTIC VALUE ADDITION**

To,

M/s INDRADHANUSH GAS GRID LIMITED
7th Floor, 122A, NRL Centre, Christian Basti, G S Road, Guwahati-781005, Assam

SUB:

TENDER NO:

Dear Sir

We, \_\_\_\_\_ the statutory auditor/ cost auditor/chartered accountant (not an employee of the company) of M/s. \_\_\_\_\_ (Name of Bidder) hereby certify that as per definition specified in policy, M/s. \_\_\_\_\_ (Name of Bidder) is:

Class-I Local supplier { }

Class-II Local Supplier { }

(Certifier is to tick appropriate option (✓) above).

It is further confirm that M/s \_\_\_\_\_ (Name of Bidder) quoted vide offer no. \_\_\_\_\_ dated \_\_\_\_\_ against tender no. \_\_\_\_\_ meet the mandatory minimum Local content/Domestic Value Addition requirement for Class-I Local supplier/ Class-II Local supplier (as the case may be) under Policy for Public Procurement (Preference to Make in India), Order 2017 (PPP-MII) and has value addition of \_\_\_\_\_%.

Name of Audit Firm: \_\_\_\_\_ [Signature of Authorized Signatory]

Date: \_\_\_\_\_ Name:

Designation:

Seal:

\_\_\_\_\_ Membership No.

**PROCEDURE FOR ACTION IN CASE CORRUPT/FRAUDULENT/COLLUSIVE/COERCIVE PRACTICES**

**A Definitions:**

- A.1 "Corrupt Practice" means the offering, giving, receiving or soliciting, directly or indirectly, anything of value to improperly influence the actions in selection process or in contract execution. "Corrupt Practice" also includes any omission for misrepresentation that may mislead or attempt to mislead so that financial or other benefit may be obtained or an obligation avoided.
- A.2 "Fraudulent Practice" means and include any act or omission committed by a agency or with his connivance or by his agent by misrepresenting/ submitting false documents and/ or false information or concealment of facts or to deceive in order to influence a selection process or during execution of contract/ order.
- A.3 "Collusive Practice amongst bidders (prior to or after bid submission)" means a scheme or arrangement designed to establish bid prices at artificial non-competitive levels and to deprive the Employer of the benefits of free and open competition.
- A.4 "Coercive practice" means impairing or harming or threatening to impair or harm directly or indirectly, any agency or its property to influence the improperly actions of an agency, obstruction of any investigation or auditing of a procurement process.
- A.5 "Vendor/Supplier/Contractor/Consultant/Bidder" is herein after referred as "Agency"
- A.6 " Appellate Authority" shall mean Committee of Directors consisting of Director (Finance) and Director (BD) for works centres under Director (Projects). For all other cases committee of Directors shall consist of Director (Finance) & Director (Projects).
- A.7 "Competent Authority" shall mean the authority, who is competent to take final decision for Suspension of business dealing with an Agency/ (ies) and banning of business dealings with Agency/ (ies) and shall be the "Director" concerned.
- A.8 "Allied Agency" shall mean all concerns which come within the sphere of effective influence of the banned/suspended agency shall be treated as allied agency. In determining this, the following factors may be taken into consideration:
- a) Whether the management is common;
  - b) Majority interest in the management is held by the partners or directors of banned/ suspended agency;
  - c) Substantial or majority shares are owned by the banned/ suspended agency and by virtue of this it has a controlling voice.
  - d) Directly or indirectly controls, or is controlled by or is under common control with another bidder.
  - e) All successor agency will also be considered as allied agency.
- A.9 "Investigating Agency" shall mean any department or unit of IGGL investigating into the conduct of Agency/ party and shall include the Vigilance Department of the IGGL, Central Bureau of

=====  
Investigation, State Police or any other agency set up by the Central or state government having power to investigate.

- A.10 "Obstructive practice": materially impede the procuring entity's investigation into allegations of one or more of the above mentioned practices either by deliberately destroying, falsifying, altering; or by concealing of evidence material to the investigation; or by making false statements to investigators and/ or by threatening, harassing or intimidating any party to prevent it from disclosing its knowledge of matters relevant to the investigation or from pursuing the investigation; or by impeding IGGL 's rights of audit or access to information.

## **B Actions against bidder(s) indulging in corrupt /fraudulent/ collusive/ coercive practice**

### **B.1 Irregularities noticed during the evaluation of the bids:**

If it is observed during bidding process/ bids evaluation stage that a bidder has indulged in corrupt/fraudulent /collusive/coercive practice, the bid of such Bidder (s) shall be rejected and its Earnest Money Deposit (EMD) shall be forfeited.

Further, such agency shall be banned for future business with IGGL for a period specified in para B 2.2 below from the date of issue of banning order.

### **B.2 Irregularities noticed after award of contract**

#### **(i) During execution of contract:**

If an agency, is found to have indulged in corrupt/fraudulent/collusive/coercive practices, action shall be initiated for putting the agency on banning list.

After conclusion of process and issuance of Speaking order for putting party on banning list, the order (s)/ contract (s) where it is concluded that such irregularities have been committed shall be terminated and Contract cum Performance Bank Guarantee (CPBG) submitted by agency against such order (s)/ contract (s) shall also be forfeited. Further such order/ contract will be closed following the due procedure in this regard.

The amount that may have become due to the contractor on account of work already executed by him shall be payable to the contractor and this amount shall be subject to adjustment against any amounts due from the contractor under the terms of the contract. No risk and cost provision will be enforced in such cases.

#### **Suspension of order/ contract:**

Further, only in the following situations, the concerned order (s)/ contract(s) (where Corrupt/Fraudulent/ Collusive/ Coercive Practices are observed) and payment shall be suspended after issuance of Suspension cum Show Cause Notice:

- (i) Head of Corporate Vigilance Department/CVO based on the investigation by them, recommend for specific immediate action against the agency.
- (ii) Head of Corporate Vigilance Department/CVO based on the input from investigating agency, forward for specific immediate action against the agency.

Suspension cum Show Cause Notice being issued in above cases after approval of the competent authority (as per provisions mentioned under Clause no. D) shall also include the provision for suspension of Order (s)/ Contract (s) and payment. Accordingly, after issuance of Suspension cum Show Cause Notice, the formal communication for suspension of Order (s)/ Contract (s) and payment with immediate effect will be issued by the concerned person of IGGL.

During suspension, Contractor/ Service Providers will be allowed to visit the plant/ site for upkeep of their items/ equipment, IGGL’s issued materials (in case custody of same is not taken over), demobilizing the site on confirmation of EIC, etc.

In addition to above, Recovery of payments (other than due payments) including balance advance payments, if any, made by along with interest thereon at the prevailing rate shall be recovered.

**(ii) After execution of contract and during Defect liability period (DLP)/ Warranty/Guarantee Period:**

If an agency is found to have indulged in corrupt/fraudulent/ collusive/coercive practices, after execution of contract and during DLP/ Warranty/Guarantee Period, the agency shall be banned for future business with IGGL for a period specified in para-B 2.2 below from the date of issue of banning order.

Further, the Contract cum Performance Bank Guarantee (CPBG)/Contract Performance Security (CPS) submitted by agency against such order (s)/ contract (s) shall be forfeited.

**(iii) After expiry of Defect liability period (DLP)/ Warranty/Guarantee Period**

If an agency is found to have indulged in corrupt/fraudulent/ collusive/coercive practices, after expiry of Defect liability period (DLP)/ Warranty/Guarantee Period, the agency shall be banned for future business with IGGL for a period specified in para-B 2.2 below from the date of issue of banning order.

**B.2.2 Period of Banning**

The period of banning of agencies indulged in Corrupt/ Fraudulent/ Collusive/Coercive Practices shall be as under and to be reckoned from the date of banning order:

Sl. No.	Description	Period of banning from the date of issuance of Banning order
1	<p>Misrepresentation/False information other than pertaining to BEC of tender but having impact on the selection process.</p> <p>For example, if an agency confirms not being in holiday in IGGL /PSU’s PMC or banned by PSUs/ Govt. Dept., liquidation, bankruptcy &amp; etc. and subsequently it is found otherwise, such acts shall be considered in this category.</p>	06 Months

2	Corrupt/Fraudulent (except mentioned at sl. no. 1 above) /Collusive/Coercive Practices	01 year
2.1	If an agency again commits Corrupt/Fraudulent (except mentioned at sl. no. 1 above) /Collusive/ Coercive Practices in subsequent cases after their banning, such situation of repeated offense to be dealt with more severity.	2 years (in addition to the period already served)
3	Indulged in unauthorized disposal of materials provided by IGGL	2 years
4	If act of vendor/ contractor is a threat to the National Security	2 years

## C Effect of banning on other ongoing contracts/ tenders

- C.1 If an agency is put on Banning, such agency should not be considered in ongoing tenders/future tenders.
- C.2 However, if such an agency is already executing other order (s)/ contract (s) where no corrupt/fraudulent/ collusive/coercive practice is found, the agency should be allowed to continue till its completion without any further increase in scope except those incidental to original scope mentioned in the contract.
- C.3 If an agency is put on the Banning List during tendering and no irregularity is found in the case under process:
- C.3.1 after issue of the enquiry /bid/tender but before opening of Technical bid, the bid submitted by the agency shall be ignored.
- C.3.2 after opening Technical bid but before opening the Price bid, the Price bid of the agency shall not be opened and BG/EMD submitted by the agency shall be returned to the agency.
- C.3.3 After opening of price, BG/EMD made by the agency shall be returned; the offer of the agency shall be ignored & will not be further evaluated. In case such agency is lowest (L-1), next lowest bidder shall be considered as L-1.

## D. Procedure for Suspension of Bidder

### D.1 Initiation of Suspension

Action for suspension business dealing with any agency/(ies) shall be initiated by Corporate C&P Department when

- (i) Corporate Vigilance Department based on the fact of the case gathered during investigation by them recommend for specific immediate action against the agency.
- (ii) Corporate Vigilance Department based on the input from Investigating agency, forward for specific immediate action against the agency.
- (iii) Non-performance of Vendor / Supplier / Contractor / Consultant leading to termination of Contract / Order.

=====

## D.2 Suspension Procedure:

- D.2.1 The order of suspension would operate initially for a period not more than six months and is to be communicated to the agency and also to Corporate Vigilance Department. Period of suspension can be extended with the approval of the Competent Authority by one month at a time with a ceiling of six months pending a conclusive decision to put the agency on banning list.
- D.2.2 During the period of suspension, no new business dealing may be held with the agency.
- D.2.3 Period of suspension shall be accounted for in the final order passed for banning of business with the agency.
- D.2.4 The decision regarding suspension of business dealings should also be communicated to the agency.
- D.2.5 If a prima-facie, case is made out that the agency is guilty on the grounds which can result in banning of business dealings, proposal for issuance of suspension order and show cause notice shall be put up to the Competent Authority. The suspension order and show cause notice must include that (i) the agency is put on suspension list and (ii) why action should not be taken for banning the agency for future business from IGGL.  
The competent authority to approve the suspension will be same as that for according approval for banning.

## D 3 Effect of Suspension of business:

Effect of suspension on other on-going/future tenders will be as under:

- D.3.1 No enquiry/bid/tender shall be entertained from an agency as long as the name of agency appears in the Suspension List.
- D.3.2 If an agency is put on the Suspension List during tendering:
- D.3.2.1 after issue of the enquiry /bid/tender but before opening of Technical bid, the bid submitted by the agency shall be ignored.
- D.3.2.2 after opening Technical bid but before opening the Price bid, the Price bid of the agency shall not be opened and BG/EMD submitted by the agency shall be returned to the agency.
- D.3.2.3 After opening of price, BG/EMD made by the agency shall be returned; the offer of the agency shall be ignored & will not be further evaluated In case such agency is lowest (L-1), next lowest bidder shall be considered as L-1.
- D.3.3 The existing contract (s)/ order (s) under execution shall continue.
- D.3.4 Tenders invited for procurement of goods, works and services shall have provision that the bidder shall submit a undertaking to the effect that (i) neither the bidder themselves nor their allied agency/(ies) are on banning list of IGGL or the Ministry of Petroleum and Natural Gas and (ii) bidder is not banned by any Government department/ Public Sector.

=====

**E. Appeal against the Decision of the Competent Authority:**

- E.1 The agency may file an appeal against the order of the Competent Authority for putting the agency on banning list. The appeal shall be filed to Appellate Authority. Such an appeal shall be preferred within one month from the of receipt of banning order.
  - E.2 Appellate Authority would consider the appeal and pass appropriate order which shall be communicated to the party as well as the Competent Authority.
  - E.3 Appeal process may be completed within 45 days of filing of appeal with the Appellate Authority.
- F.** Wherever there is contradiction with respect to terms of 'Integrity pact', GCC and 'Procedure for action in case of Corrupt/Fraudulent/ Collusive/Coercive Practice', the provisions of 'Procedure for action in case of Corrupt/Fraudulent/ Collusive/Coercive Practice' shall prevail.

=====

## ANNEXURE-V

### PROCEDURE FOR EVALUATION OF PERFORMANCE OF VENDORS/ SUPPLIERS/ CONTRACTORS/ CONSULTANTS

#### 1.0 GENERAL

A system for evaluation of Vendors/ Suppliers/Contractors/ Consultants and their performance is a key process and important to support an effective purchasing & contracting function of an organization.

Performance of all participating Vendors/ Suppliers/Contractors/ Consultants need to be closely monitored to ensure timely receipt of supplies from a Vendor, completion of an assignment by a Consultant or complete execution of order by a contractor within scheduled completion period. For timely execution of projects and meeting the operation & maintenance requirement of operating plants, it is necessary to monitor the execution of order or contracts right from the award stage to completion stage and take corrective measures in time.

#### 2.0 OBJECTIVE

The objective of Evaluation of Performance aims to recognize and develop reliable Vendors/ Suppliers/Contractors/ Consultants so that they consistently meet or exceed expectations and requirements.

The purpose of this procedure is to put in place a system to monitor performance of Vendors/ Suppliers/Contractors/ Consultants associated with IGGL so as to ensure timely completion of various projects, timely receipt of supplies including completion of works & services for operation and maintenance of operating plants and quality standards in all respects.

#### 3.0 METHODOLOGY

i) Preparation of Performance Rating Data Sheet

Performance rating data Sheet for each and every Vendor/ Supplier/Contractor/Consultant for all orders/Contracts with a value of Rs. 50 Lakhs and above is recommended to be drawn up. Further, Performance rating data Sheet for orders/contracts of Vendor/Supplier/Contractor/ Consultant who are on watch list/holiday list/ banning list shall be prepared irrespective of order/ contract value. These data sheets are to be separately prepared for orders/ contracts related to Projects and O&M. Format, Parameters, Process, responsibility for preparation of Performance Rating Data Sheet are separately mentioned.

ii) Measurement of Performance

Based on the parameters defined in Data Sheet, Performance of concerned Vendor/ Supplier/Contractor/ Consultant would be computed and graded accordingly. The measurement of the performance of the Party would be its ability to achieve the minimum scoring of 60% points in the given parameters.

iii) Initiation of Measures:

Depending upon the Grading of Performance, corrective measures would be initiated by taking up the matter with concerned Vendor/ Supplier/Contractor/ Consultant. Response of Vendor/ Supplier/Contractor/ Consultant would be considered before deciding further course of action.

- =====
- iv) Implementation of Corrective Measures:  
Based on the response of Vendor/ Supplier/Contractor/ Consultant, concerned Engineer-in-Charge for the Projects and/or OIC in case of O&M would recommend for continuation or discontinuation of such party from the business of IGGL.
  - v) Orders/contracts placed on Proprietary/OEM basis for O&M will be evaluated and, if required, corrective action will be taken for improvement in future.

#### 4.0 **EXCLUSIONS:**

The following would be excluded from the scope of evaluation of performance of Vendors/ Suppliers/Contractors/ Consultants:

- i) Orders/Contracts below the value of Rs. 50 Lakhs if Vendor/ Supplier/Contractor/ Consultant is not on watch list/ holiday list/ banning list.
- ii) Orders for Misc./Administrative items/ Nonstock Non valued items.

However, concerned Engineer-in-Charge /OICs will continue to monitor such cases so as to minimize the impact on Projects/O&M plants due to non-performance of Vendors/ Suppliers/Contractors/ Consultants in all such cases.

#### 5.0 **PROCESS OF EVALUATION OF PERFORMANCE OF VENDORS/ SUPPLIERS/ CONTRACTORS/ CONSULTANTS**

##### 5.1 FOR PROJECTS

- i) Evaluation of performance of Vendors/ Suppliers/Contractors/ Consultants in case of PROJECTS shall be done immediately with commissioning of any Project.
- ii) On commissioning of any Project, EIC (Engineer-in-charge)/ Project-in-charge shall prepare a Performance Rating Data Sheet (Format at Annexure-1) for all Orders and Contracts.
- iii) Depending upon the Performance Rating, following action shall be initiated by Engineer-in-charge/Project-in-charge:

Sl.No.	Performance Rating	Action
1	POOR	Seek explanation for Poor performance
2	FAIR	Seek explanation for Fair performance
3	GOOD	Letter to the concerned for improving performance in future
4	VERY GOOD	No further action

- iv) Reply from concerned Vendor/ Supplier/Contractor/ Consultant shall be examined. In case of satisfactory reply, Performance Rating data Sheet to be closed with a letter to the concerned for improving performance in future.
- v) When no reply is received or reasons indicated are unsatisfactory, the following actions need to be taken:

- =====
- A) Where performance rating is "POOR" (as per Performance Rating carried out after execution of Order/ Contract and where no reply/ unsatisfactory reply is received from party against the letter seeking the explanation from Vendor/Supplier/Contractor/ Consultant along with sharing the performance rating)

Recommend such defaulting Vendor / Supplier / Contractor / Consultant for the following action:

1. Poor Performance on account of Quality (if marks obtained against Quality parameter is less than 20):
  - (a) **First Instance: Holiday (Red Card) for One Year**
  - (b) **Subsequent instance (s) in other ongoing order (s)/ contract (s) or new order (s) /contact (s) on such Vendor/ Supplier/ Contractor/ Consultant: Holiday (Red Card) for Two Years**
2. Poor Performance on account of other than Quality (if marks obtained against Quality parameter is more than 20):
  - (a) **First such instance: Advisory notice (Yellow Card)** shall be issued and Vendor/Supplier/Contractor/ Consultant shall be put on watch list for a period of Two (2) Years.
  - (b) **Second such instance in other ongoing order (s)/ contract (s) or new order (s) /contact (s) on such Vendor/ Supplier/ Contractor/ Consultant: Putting on Holiday (Red Card) for a period of One Year**
  - (c) **Subsequent instances (more than two) in other ongoing order (s)/ contract (s) or new order (s) /contact (s) on such Vendor/ Supplier/ Contractor/ Consultant: Putting on Holiday (Red Card) for a period of Two Years.**

- B) Where Poor/Non-Performance leading to termination of contract or Offloading of contract due to poor performance attributable to Vendor/Supplier/ Contractor/Consultant (under Clause no. 2.17.3 of GCC-Services)

- (a) **First instance: Advisory notice (Yellow Card)** shall be issued and Vendor/Supplier/Contractor /Consultant shall be put on watch list for a period of Two (2) Years.

Further such vendor will not be allowed to participate in the re-tender of the same supply/work/services of that location which has terminated / offloaded. Moreover, it will be ensured that all other action as per provision of contract including forfeiture of Contract Performance Security (CPS) etc. are undertaken.

However, such vendor will be allowed to participate in all other tenders and to execute other ongoing order/ contract (s) or new contract/ order (s).

The Yellow card will be automatically revoked after a period of two years unless the same is converted into Red Card due to subsequent instances of poor/ non-performance in other ongoing order (s)/ contract (s) or new order (s) /contact (s) on such Vendor/ Supplier/ Contractor/ Consultant.

=====

(b) **Second instances** in other ongoing order (s)/ contract (s) or new order (s) /contact (s) on such Vendor/ Supplier/ Contractor/ Consultant: **Holiday (Red Card)** for period of One Year and they shall also to be considered for Suspension.

(c) **Subsequent instances (more than two)** in other ongoing order (s)/ contract (s) or new order (s) /contact (s) on such Vendor/ Supplier/ Contractor/ Consultant: **Holiday (Red Card) for period of Two Years and they shall also to be considered for Suspension.**

(C) Where Performance rating is "FAIR":  
 Issuance of warning to such defaulting Vendor/ Supplier/Contractor/ Consultant to improve their performance.

## 5.2 FOR CONSULTANCY JOBS

Monitoring and Evaluation of consultancy jobs will be carried out in the same way as described in para 5.1 for Projects.

## 5.3 FOR OPERATION & MAINTENANCE

- i) Evaluation of performance of Vendors/ Suppliers/Contractors/ Consultants in case of Operation and Maintenance shall be done immediately after execution of order/ contract.
- ii) After execution of orders a Performance Rating Data Sheet (Format at Annexure-2) shall be prepared for Orders by Site C&P and for Contracts/Services by respective Engineer-In-Charge.
- iii) Depending upon Performance Rating, following action shall be initiated by EIC:

Sl. No.	Performance Rating	Action
1	<b>POOR</b>	Seek explanation for Poor performance
2.	<b>FAIR</b>	Seek explanation for Fair performance
3	<b>GOOD</b>	Letter to the concerned for improving performance in future.
4	<b>VERY GOOD</b>	No further action

iv) Reply from concerned Vendor/ Supplier/Contractor/ Consultant shall be examined. In case of satisfactory reply, Performance Rating data Sheet to be closed with a letter to the concerned for improving performance in future.

v) When no reply is received or reasons indicated are unsatisfactory, the following actions need to be taken:

A) Where performance rating is "POOR" (as per Performance Rating carried out after execution of Order/ Contract and where no reply/ unsatisfactory reply is received from party against the letter seeking the explanation from Vendor/Supplier/Contractor/ Consultant along with sharing the performance rating)

=====

Recommend such defaulting Vendor / Supplier / Contractor / Consultant for the following action:

1. Poor Performance on account of Quality (if marks obtained against Quality parameter is less than 20):

(a) **First Instance: Holiday (Red Card) for One Year**

(b) **Subsequent instance (s) in other ongoing order (s)/ contract (s) or new order (s) /contract (s) on such Vendor/ Supplier/ Contractor/ Consultant: Holiday (Red Card) for Two Years**

2. Poor Performance on account of other than Quality (if marks obtained against Quality parameter is more than 20):

(a) **First such instance: Advisory notice (Yellow Card)** shall be issued and Vendor/Supplier/Contractor/ Consultant shall be put on watch list for a period of Two (2) Years.

(b) **Second such instance in other ongoing order (s)/ contract (s) or new order (s) /contract (s) on such Vendor/ Supplier/ Contractor/ Consultant: Putting on Holiday (Red Card) for a period of One Year**

(c) **Subsequent instances (more than two) in other ongoing order (s)/ contract (s) or new order (s) /contract (s) on such Vendor/ Supplier/ Contractor/ Consultant: Putting on Holiday (Red Card) for a period of Two Years.**

B) Where Poor/Non-Performance leading to termination of contract or Offloading of contract due to poor performance attributable to Vendor/Supplier/ Contractor/Consultant under Clause no. 2.17.3 of GCC-Services)

(a) **First instance: Advisory notice (Yellow Card)** shall be issued and Vendor/Supplier/Contractor /Consultant shall be put on watch list for a period of Two (2) Year.

Further such vendor will not be allowed to participate in the re-tender of the same supply/work/services of that location which has terminated / offloaded. Moreover, it will be ensured that all other action as per provision of contract including forfeiture of Contract Performance Security (CPS) etc. are undertaken.

However, such vendor will be allowed to participate in all other tenders and to execute other ongoing order/ contract (s) or new contract/ order (s).

The Yellow card will be automatically revoked after a period of two years unless the same is converted into Red Card due to subsequence instances of poor/ non-performance in other ongoing order (s)/ contract (s) or new order (s) /contract (s) on such Vendor/ Supplier/ Contractor/ Consultant.

(b) **Second instances** in other ongoing order (s)/ contract (s) or new order (s) /contract (s) on such Vendor/ Supplier/ Contractor/ Consultant: **Holiday (Red Card)** for period of One Year and they shall also to be considered for Suspension.

=====

(c) **Subsequent instances (more than two)** in other ongoing order (s)/ contract (s) or new order (s) /contact (s) on such Vendor/ Supplier/ Contractor/ Consultant: **Holiday (Red Card) for period of Two Years and they shall also to be considered for Suspension.**

(C) Where Performance rating is "FAIR"  
Issuance of warning to such defaulting Vendors/Contractors/Consultants to improve their performance.

## 6.0 **REVIEW & RESTORATION OF PARITES PUT ON HOLIDAY**

6.1 An order for Holiday passed for a certain specified period shall deemed to have been automatically revoked on the expiry of that specified period and it will not be necessary to issue a specific formal order of revocation.

Further, in case Vendor/ Supplier/Contractor/ Consultant is put on holiday due to quality, and new order is placed on bidder after restoration of Vendor/ Supplier/Contractor/ Consultant, such order will be properly monitored during execution stage by the concerned site.

## 7.0 **EFFECT OF HOLIDAY**

7.1 If a Vendor/ Supplier/Contractor/ Consultant is put on Holiday, such Vendor/ Supplier/Contractor/ Consultant shall not be considered in ongoing tenders/future tenders.

7.2 However, if such Vendor/ Supplier/Contractor/ Consultant is already executing any other order/ contract and their performance is satisfactory in terms of the relevant contract, should be allowed to continue till its completion without any further increase in scope except those incidental to original scope mentioned in the contract. In such a case CPBG will not be forfeited and payment will be made as per provisions of concerned contract. However, this would be without prejudice to other terms and conditions of the contract.

7.3. Effect on other ongoing tendering:

7.3.1 after issue of the enquiry /bid/tender but before opening of Technical bid, the bid submitted by the party shall be ignored.

7.3.2 after opening Technical bid but before opening the Price bid, the Price bid of the party shall not be opened and BG/EMD submitted by the party shall be returned to the party.

7.3.3 After opening of price, BG/EMD made by the agency shall be returned; the offer of the agency shall be ignored & will not be further evaluated. In case such agency is lowest (L-1), next lowest bidder shall be considered as L-1.

8.0 While putting the Vendor/ Supplier/Contractor/ Consultant on holiday as per the procedure, the holding company, subsidiary, joint venture, sister concerns, group division of the errant Vendor/ Supplier/Contractor/ Consultant shall not be considered for putting on holiday list.

Any bidder, put on holiday, will not be allowed to bid through consortium route also in new tender during the period of holiday.

9.0 If an unsuccessful bidder makes any vexatious, frivolous or malicious complaint against the tender process with the intention of delaying or defeating any procurement or causing loss to IGGL or any other bidder, such bidder will be put on holiday for a period of six months, if such complaint is proved to be vexatious, frivolous or malicious, after following the due procedure.

=====

## 10. **APPEAL AGAINST THE DECISION OF THE COMPETENT AUTHORITY:**

- (a) The party may file an appeal against the order of the Competent Authority for putting the party on Holiday list. The appeal shall be filed to Appellate Authority. Such an appeal shall be preferred within one month from the of receipt of Holiday order.
- (b) Appellate Authority would consider the appeal and pass appropriate order which shall be communicated to the party as well as the Competent Authority.
- (c) Appeal process may be completed within 45 days of filing of appeal with the Appellate Authority.
- (d) "Appellate Authority" shall mean Committee of Directors consisting of Director (Finance) and Director (BD) for works centers under Director (Projects). For all other cases committee of Directors shall consist of Director (Finance) & Director (Projects).

## 11. **ERRANT BIDDER**

In case after price bid opening the lowest evaluated bidder (L1) is not awarded the job for any mistake committed by him in bidding or withdrawal of bid or modification of bid or varying any term in regard thereof leading to re-tendering, IGGL shall forfeit EMD if paid by the bidder and such bidders shall be debarred from participation in retendering of the same job(s)/item(s).

Further, such bidder will be put on Watch List (Yellow Card) for a period of two years after following the due procedure. However, during the period in watch list such vendor will be allowed to participate in all other tenders and to execute other ongoing order/ contract (s) or new contract/ order (s).

In case of subsequent instances of default in other tender(s) during aforesaid watch list period, the action shall be initiated as per provision of sl. no. 2 of para-A of Clause no. 5.1 (v) and 5.3 (v).

The Yellow card will be automatically revoked after specified period unless the same is converted into Red Card.

- 12. In case CBIC (Central Board of Indirect Taxes and Customs)/ any tax authority / any equivalent government agency brings to the notice of IGGL that the Supplier has not remitted the amount towards GST (CGST & SGST/UTGST or IGST) collected from IGGL to the government exchequer, then, that Supplier shall be put under Holiday list of IGGL for period of six months after following the due procedure. This action will be in addition to the right of recovery of financial implication arising on IGGL.

**IGGL  
PERFORMANCE RATING DATA SHEET  
(FOR PROJECTS/ CONSULTANCY JOBS)**

- i) Project/Work Centre :
- ii) Order/ Contract No. & date :
- iii) Brief description of Items :  
Works/Assignment
- iv) Order/Contract value (Rs.) :
- v) Name of Vendor/Supplier/ :  
Contractor/ Consultant
- vi) Contracted delivery/ :  
Completion Schedule
- vii) Actual delivery/ :  
Completion date

Performance Parameter	Delivery/ Completion Performance	Quality Performance	Reliability Performance#	Total
Maximum Marks	40	40	20	100
Marks Allocated (*)				

Note:

Remarks (if any)

PERFORMANCE RATING (\*\*)

Note :

(#) Vendor/Supplier/Contractor/Consultant who seek repeated financial assistance or deviation beyond contract payment term or seeking direct payment to the sub-vendor/sub-contractor due to financial constraints, then '0' marks should be allotted against Reliability Performance.

(\*) Allocation of marks should be as per enclosed instructions

(\*\*) Performance rating shall be classified as under:

Sl. No.	Range (Marks)	Rating
1	60 & below	POOR
2	61-75	FAIR
3	76-90	GOOD
4	More than 90	VERY GOOD

Signature of  
Authorised Signatory:

Name:

Designation:

=====

## Instructions for allocation of marks

1. Marks are to be allocated as under:

### 1.1 DELIVERY/ COMPLETION PERFORMANCE 40 Marks

Delivery Period/ Completion Schedule	Delay in Weeks	Marks
a) Upto 3 months	Before CDD	40
	Delay upto 4 weeks	35
	" 8 weeks	30
	" 10 weeks	25
	" 12 weeks	20
	" 16 weeks	15
	More than 16 weeks	0
b) Above 3 months	Before CDD	40
	Delay upto 4 weeks	35
	" 8 weeks	30
	" 10 weeks	25
	" 16 weeks	20
	" 20 weeks	15
	" 24 weeks	10
More than 24 weeks	0	

### 1.2 QUALITY PERFORMANCE 40 Marks

For Normal Cases : No Defects/ No Deviation/ No failure:		40 marks
i) Rejection/Defects	Marks to be allocated on prorata basis for acceptable quantity as compared to total quantity for normal cases	10 marks
ii) When quality failure endanger system integration and safety of the system	- Failure of severe nature	0 marks
	- Moderate nature	5 marks
	- low severe nature	10-25 marks
iii) Number of deviations	1. No deviation	5 marks
	2. No. of deviations $\leq 2$	2 marks
	3. No. of deviations $> 2$	0 marks

## 1.3 RELIABILITY PERFORMANCE

20 Marks

<b>A.</b>	<b>FOR WORKS/CONTRACTS</b>	
i)	Submission of order acceptance, agreement, PBG, Drawings and other documents within time	4 marks
ii)	Mobilization of resources as per Contract and in time	4 marks
iii)	Liquidation of Check-list points	4 marks
iv)	Compliance to statutory and HS&E requirements  or  Reliability of Estimates/Design/Drawing etc. in case of Consultancy jobs	4 marks
v)	Timely submission of estimates and other documents for Extra, Substituted & AHR items	4 marks
<b>B.</b>	<b>FOR SUPPLIES</b>	
i)	Submission of order acceptance, PBG, Drawings and other documents within time	5 marks
ii)	Attending complaints and requests for after sales service/ warranty repairs and/ or query/ advice (upto the evaluation period).	5 marks
iii)	Response to various correspondence and conformance to standards like ISO	5 marks
iv)	Submission of all required documents including Test Certificates at the time of supply	5 marks

**Indradhanush Gas Grid Limited (IGGL)  
PERFORMANCE RATING DATA SHEET  
(FOR O&M)**

- i) Location :
- ii) Order/ Contract No. & date :
- iii) Brief description of Items :  
Works/Assignment :
- iv) Order/Contract value (Rs.) :
- v) Name of Vendor/Supplier/ :  
Contractor/ Consultant :
- vi) Contracted delivery/ :  
Completion Schedule :
- vii) Actual delivery/ :  
Completion date :

Performance Parameter	Delivery Performance	Quality Performance	Reliability Performance#	Total
Maximum Marks	40	40	20	100
Marks Allocated (*)				

Remarks (if any)

PERFORMANCE RATING (\*\*)

Note:

- (#) Vendor/Supplier/Contractor/Consultant who seek repeated financial assistance or deviation beyond contract payment term or seeking direct payment to the sub-vendor/sub-contractor due to financial constraints, then '0' marks should be allotted against Reliability Performance
- (\*) Allocation of marks should be as per enclosed instructions
- (\*\*) Performance rating shall be classified as under:

Sl. No.	Range (Marks)	Rating
1	60 & below	POOR
2	61-75	FAIR
3	76-90	GOOD
4	More than 90	VERY GOOD

Signature of  
Authorised Signatory:

Name:

Designation:

=====

**Instructions for allocation of marks (For O&M)**

1. Marks are to be allocated as under:

**1.1 DELIVERY/ COMPLETION PERFORMANCE 40 Marks**

Delivery Period/ Completion Schedule	Delay in Weeks	Marks
a) Upto 3 months	Before CDD	40
	Delay upto 4 weeks	35
	" 8 weeks	30
	" 10 weeks	25
	" 12 weeks	20
	" 16 weeks	15
	More than 16 weeks	0
b) Above 3 months	Before CDD	40
	Delay upto 4 weeks	35
	" 8 weeks	30
	" 10 weeks	25
	" 16 weeks	20
	" 20 weeks	15
	" 24 weeks	10
More than 24 weeks	0	

**1.2 QUALITY PERFORMANCE 40 Marks**

For Normal Cases : No Defects/ No Deviation/ No failure:		40 marks
i) Rejection/Defects	Marks to be allocated on prorata basis for acceptable quantity as compared to total quantity for normal cases	10 marks
ii) When quality failure endanger system integration and safety of the system	Failure of severe nature	0 marks
	- Moderate nature	5 marks
	- low severe nature	10-25 marks
iii) Number of deviations	1. No deviation	5 marks
	2. No. of deviations $\leq 2$	2 marks
	3. No. of deviations $> 2$	0 marks

## 1.3 RELIABILITY PERFORMANCE

20 Marks

<b>A.</b>	<b>FOR WORKS/CONTRACTS</b>	
i)	Submission of order acceptance, agreement, PBG, Drawings and other documents within time	4 marks
ii)	Mobilization of resources as per Contract and in time	4 marks
iii)	Liquidation of Check-list points	4 marks
iv)	Compliance to statutory and HS&E requirements or Reliability of Estimates/Design/Drawing etc. in case of Consultancy jobs	4 marks
v)	Timely submission of estimates and other documents for Extra, Substituted & AHR items	4 marks
<b>B.</b>	<b>FOR SUPPLIES</b>	
i)	Submission of order acceptance, PBG, Drawings and other documents within time	5 marks
ii)	Attending complaints and requests for after sales service/ warranty repairs and/ or query/ advice (upto the evaluation period).	5 marks
iii)	Response to various correspondence and conformance to standards like ISO	5 marks
iv)	Submission of all required documents including Test Certificates at the time of supply	5 marks

---

**SECTION-IV**

**GENERAL CONDITIONS OF CONTRACT (GCC)**

**FOR**

**PROCUREMENT OF GOODS**

**IGGL**

---

## INDEX

<b><u>Article</u></b>	<b><u>Title</u></b>
1.	Definitions
2.	Seller to inform
3.	Application
4.	Country of origin
5.	Scope of Contract
6.	Standards
7.	Instructions, direction & correspondence
8.	Contract Obligations
9.	Modification in Contract
10.	Use of Contract Documents & Information
11.	Patent Rights, Liability & Compliance of Regulations
12.	Performance Guarantee
13.	Inspection, Testing & Expediting
14.	Time Schedule & Progress Reporting
15.	Delivery & Documents
16.	Transit Risk Insurance
17.	Transportation
18.	Incidental Services
19.	Spare Parts, Maintenance Tools, Lubricants
20.	Guarantee
21.	Terms of Payment
22.	Prices
23.	Subletting & assignment
24.	Time as Essence of Contract
25.	Delays in the Seller's Performance
26.	Price Reduction Schedule for Delayed delivery
27.	Rejections, Removal of rejected equipment & replacement
28.	Termination of Contract
29.	Force Majeure
30.	Resolution of disputes/arbitration
31.	Governing Language
32.	Notices
33.	Taxes & Duties
34.	Books & Records
35.	Permits & Certificates
36.	General
37.	Import Licence
38.	Fall clause
39.	Publicity & Advertising
40.	Repeat Order
41.	Limitation of Liability

=====

## 1. Definitions

In this document, General Conditions of Contract (GCC-Goods), the following terms shall have the following respective meanings:

- 1.0 BIDDER: Designates the individual or legal entity which has made a proposal, a tender or a bid with the aim of concluding a Contract with the PURCHASER.
- 1.1 CONSULTANT [if engaged] shall mean M/s. ....having its registered office at the term consultant includes successors, assigns of M/s.....
- 1.2 CONTRACT shall mean Purchase Order/Contract and all attached exhibits and documents referred to therein and all terms and conditions thereof together with any subsequent modifications thereto.
- 1.3 CONTRACT PRICE shall mean the price payable to the Seller under the Contract for the full and proper performance of his contractual obligations.
- 1.4 COMPLETION DATE shall mean the date on which the goods are successfully commissioned by the Seller and handed over to the PURCHASER.
- 1.5 COMMERCIAL OPERATION shall mean the condition of the operation in which the complete equipment covered under the Contract is officially declared by the PURCHASER to be available for continuous operation at different loads up to and including rated capacity.
- 1.6 DELIVERY terms shall be interpreted as per INCO TERMS 2000 in case of Contract with a foreign Bidder and as the date of LR/GR in the case of a contract with an Indian Bidder.
- 1.7 DRAWINGS shall mean and include Engineering drawings, sketches showing plans, sections and elevations in relation to the Contract together with modifications and/or revisions thereto.
- 1.8 ENGINEER or Engineer-in-Charge of the Project SITE shall mean the person designated from time to time by PURCHASER/CONSULTANT at SITE and shall include those who are expressly authorized by him to act for and on his behalf for operation of this CONTRACT.
- 1.9 FINAL ACCEPTANCE shall mean the PURCHASER's written acceptance of the Works performed under the Contract after successful completion of performance and guarantee test.
- 1.10 GOODS shall mean articles, materials, equipment, design and drawings, data and other property to be supplied by Seller to complete the contract.
- 1.11 INSPECTOR shall mean any person or outside Agency nominated by PURCHASER/CONSULTANT through CONSULTANT to inspect equipment, stagewise as well as final, before dispatch, at SELLER's works and on receipt at SITE as per terms of the CONTRACT.

=====

1.12 INITIAL OPERATION shall mean the first integral operation of the complete equipment covered under the Contract with sub-systems and supporting equipment in service or available for service.

1.13 PURCHASER shall mean IGGL having its registered office at IGGL, 7<sup>th</sup> floor, NRL Centre, 122A GS road Cristian Basti, Guwahati, Assam. The term PURCHASER includes successors, assigns of IGGL.

1.14 PERFORMANCE AND GUARANTEE TESTS shall mean all operational checks and tests required to determine and demonstrate capacity, efficiency and operating characteristics as specified in the Contract documents.

PROJECT designates the aggregate of the Goods and/or Services to be provided by one or more Contractors.

Quantities – Bills of quantities

Bills of quantities

Designate the quantity calculations to be taken into account when these calculations are made from detailed or construction drawings, or from work actually performed, and presented according to a jointly agreed breakdown of the Goods and/or Services.

1.15 SELLER shall mean the person, firm or company with whom PURCHASE ORDER/CONTRACT is placed/ entered into by PURCHASER for supply of equipment, materials and services. The term Seller includes its successors and assigns.

1.16 SERVICE shall mean erection, installation, testing, commissioning, provision of technical assistance, training and other such obligations of the Seller covered under the Contract.

1.17 SITE designates the land and/or any other premises on, under, in or across which the Goods and/or Services have to be supplied, erected, assembled, adjusted, arranged and/or commissioned.

1.18 SPECIFICATIONS shall mean and include schedules, details, description, statement of technical data, performance characteristics, standards (Indian as well as International) as applicable and specified in the Contract.

1.19 SUB-CONTRACT shall mean order placed by the Seller, for any portion of the contracted work, after necessary consent and approval of PURCHASER.

1.20 SUB-CONTRACTOR shall mean the person named in the CONTRACT for any part of the work or any person to whom any part of the CONTRACT has been sub-let by the SELLER with the consent in writing of the CONSULTANT/PURCHASER and will include the legal representatives, successors, and permitted assigns of such person.

- 
- 1.21 START-UP shall mean the time period required to bring the equipments covered under the Contract from an inactive condition, when construction is essentially complete to the state of readiness for trial operation. The start-up period shall include preliminary inspection and check out of equipment and supporting subsystems, initial operation of the complete equipments covered under the Contract to obtain necessary pre-trial operation data, perform calibration and corrective action, shutdown inspection and adjustment prior to the trial operation period.
- 1.22 TESTS shall mean such process or processes to be carried out by the Seller as are prescribed in the Contract or considered necessary by PURCHASER or his representative in order to ascertain quality, workmanship, performance and efficiency of equipment or part thereof.
- 1.23 TESTS ON COMPLETION shall mean such tests as prescribed in the Contract to be performed by the Seller before the Works are taken over by the PURCHASER.

## **2. Seller to Inform**

- 2.1 The Seller shall be deemed to have carefully examined all contract documents to his entire satisfaction. Any lack of information shall not in any way relieve the Seller of his responsibility to fulfil his obligation under the Contract.

## **3. Application**

- 3.1 These General Conditions of Contract (GCC-Goods) shall apply to the extent that they are not superseded by the provisions of other parts of the Contract.

## **4. Country of Origin**

- 4.1 For purposes of this Clause "origin" means the place where the Goods were mined, grown or produced, or from which the services are supplied. Goods are produced when, through manufacturing, processing or substantial and major assembling of components, a commercially recognized new product results that is substantially different in basic characteristics or in purpose or utility from its components.

## **5. Scope of Contract**

- 5.1 Scope of the CONTRACT shall be as defined in the PURCHASE ORDER/CONTRACT specifications, drawings and Annexure thereto.
- 5.2 Completeness of the EQUIPMENT shall be the responsibility of the SELLER. Any equipment, fittings and accessories which may not be specifically mentioned in the specifications or drawings, but which are usual or necessary for the satisfactory functioning of the equipment (successful operation and functioning of the EQUIPMENT being SELLER's responsibility) shall be provided by SELLER without any extra cost.
- 5.3 The SELLER shall follow the best modern practices in the manufacture of high-grade EQUIPMENT notwithstanding any omission in the specifications. The true intent and meaning of these documents are that SELLER shall in all respects, design, engineer,

=====

manufacture and supply the equipment in a thorough workmanlike manner and supply the same in prescribed time to the entire satisfaction of PURCHASER.

- 5.4 The documents once submitted by the SELLER shall be firm and final and not subject to subsequent changes. The SELLER shall be responsible for any loss to the PURCHASER/CONSULTANT consequent to furnishing of incorrect data/drawings.
- 5.5 All dimensions and weight should be in metric system.
- 5.6 All equipment to be supplied and work to be carried out under the CONTRACT shall conform to and comply with the provisions of relevant regulations/Acts (State Government or Central Government) as may be applicable to the type of equipment/work carried out and necessary certificates shall be furnished.
- 5.7 The Seller shall provide cross sectional drawings, wherever applicable, to identify the spare part numbers and their location. The size of bearings, their make and number shall be furnished.
- 5.8 Specifications, design and drawings issued to the SELLER along with RFQ and CONTRACT are not sold or given but loaned. These remain property of PURCHASER/CONSULTANT or its assigns and are subject to recall by PURCHASER/CONSULTANT. The SELLER and his employees shall not make use of the drawings, specifications and technical information for any purpose at any time except for manufacture against the CONTRACT and shall not disclose the same to any person, firm or corporate body, without written permission of PURCHASER/CONSULTANT. All such details shall be kept confidential.
- 5.9 SELLER shall pack, protect, mark and arrange for despatch of EQUIPMENT as per instructions given in the CONTRACT.

## **6. Standards:**

- 6.1 The GOODS supplied under the CONTRACT shall conform to the standards mentioned in the Technical Specifications, or such other standards which ensure equal or higher quality, and when no applicable standard is mentioned, to the authoritative standard appropriate to the GOODS' country of origin and such standards shall be the latest issued by the concerned institution.

## **7. Instructions, Direction & Correspondence:**

- 7.1 The materials described in the CONTRACT are to be supplied according to the standards, data sheets, tables, specifications and drawings attached thereto and/or enclosed with the CONTRACT, itself and according to all conditions, both general and specific enclosed with the contract, unless any or all of them have been modified or cancelled in writing as a whole or in part.
  - a. All instructions and orders to the SELLER shall, excepting what is herein provided, be given by PURCHASER/CONSULTANT.
  - b. All the work shall be carried out under the direction of and to the satisfaction of the PURCHASER/CONSULTANT.

- =====
- c. All communications including technical/commercial clarifications and/or comments shall be addressed to CONSULTANT in quintuplicate with a copy to PURCHASER and shall always bear reference to the CONTRACT.
  - d. Invoices for payment against CONTRACT shall be addressed to PURCHASER.
  - e. The CONTRACT number shall be shown on all invoices, communications, packing lists, containers and bills of lading, etc.

## 8. Contract Obligations

- 8.1 If after award of the contract, the Seller does not acknowledge the receipt of award or fails to furnish the performance guarantee within the prescribed time limit, the PURCHASER reserves the right to cancel the contract and apply all remedies available to him under the terms and conditions of this contract.
- 8.2 Once a contract is confirmed and signed, the terms and conditions contained therein shall take precedence over the Seller's bid and all previous correspondence.

## 9. Modification in Contract

- 9.1 All modifications leading to changes in the CONTRACT with respect to technical and/or commercial aspects including terms of delivery, shall be considered valid only when accepted in writing by PURCHASER/CONSULTANT by issuing amendment to the CONTRACT. Issuance of acceptance or otherwise in such cases shall not be any grounds for extension of the agreed delivery date and also shall not affect the performance of contract in any manner except to the extent mutually agreed through a modification of contract.
- 9.2 PURCHASER/CONSULTANT shall not be bound by any printed conditions or provisions in the SELLER's Bid Forms or acknowledgment of CONTRACT, invoices, packing list and other documents which purport to impose any conditions at variance with or supplemental to CONTRACT.

## 10. Use of Contract Documents & Information

- 10.1 The Seller shall not, without the PURCHASER's/ CONSULTANT's prior written consent, disclose the CONTRACT or any provision thereof, or any specification, plan, drawing, pattern, sample or information furnished by or on behalf of the PURCHASER in connection therewith, to any person other than a person employed by the SELLER in the performance of the CONTRACT. Disclosure to any such employed person shall be made in confidence and shall extend only so far as may be necessary for the purpose of such performance.
- 10.2 The SELLER shall not, without the PURCHASER's prior written consent, make use of any document or information enumerated in Article 10.1. except for purpose of performing the CONTRACT.

## 11. Patent Rights, Liability & Compliance of Regulations

- 11.1 SELLER hereby warrants that the use or sale of the materials delivered hereunder will not infringe claims of any patent covering such material and SELLER agrees to be responsible

=====

for and to defend at his sole expense all suits and proceedings against PURCHASER based on any such alleged patent infringement and to pay all costs, expenses and damages which PURCHASER and/or CONSULTANT may have to pay or incur by reason of any such suit or proceedings.

- 11.2 The SELLER shall indemnify the PURCHASER against all third-party claims of infringement of patent, trademark or industrial design rights arising from use of the GOODS or any part thereof in the PURCHASER's country.
- 11.3 SELLER shall also protect and fully indemnify the PURCHASER from any claims from SELLER'S workmen/employees or their heirs, dependants, representatives, etc. or from any other person/persons or bodies/companies etc. for any acts of commissions or omission while executing the CONTRACT.
- 11.4 SELLER shall be responsible for compliance with all requirements under the laws and shall protect and indemnify completely the PURCHASER from any claims/penalties arising out of any infringements.

## **12. Performance Guarantee**

- 12.1 Within 30 (Thirty) days after the SELLER's receipt of notification of award of the CONTRACT, the SELLER shall furnish Performance Guarantee in the form of Bank Guarantee, e-Bank Guarantee, Demand Draft (DD), Banker's Cheque, Insurance Security Bond, Fixed Deposit Receipt or irrevocable Letter of Credit to the PURCHASER, in the form provided in the Bidding Documents, for an amount equivalent to 5% of the total value of the CONTRACT.
- 12.2 The proceeds of Performance Guarantee shall be appropriated by the PURCHASER as compensation for any loss resulting from the SELLER's failure to complete his obligations under the CONTRACT without prejudice to any of the rights or remedies the PURCHASER may be entitled to as per terms and conditions of CONTRACT. The proceeds of this Performance Guarantee shall also govern the successful performance of Goods and Services during the entire period of the Contractual Warrantee/Guarantee.
- 12.3 The performance guarantee shall be denominated in the currency of CONTRACT.
- 12.4 The Performance Guarantee shall be valid for the duration of 90 days beyond the expiry of Warrantee/Guarantee period. The Bank Guarantee will be discharged by PURCHASER not later than 6 months from the date of expiration of the Seller's entire obligations, including any warrantee obligations, under the CONTRACT.

## **13. Inspection, Testing & Expediting:**

- 13.1 The PURCHASER or its representative shall have the right to inspect and/or to test the GOODS to confirm their conformity to the CONTRACT specifications. The special conditions of CONTRACT and/or the Technical Specifications shall specify what inspections and tests the PURCHASER requires and where they are to be conducted. The PURCHASER shall notify the SELLER in writing the identity of any representative(s) retained for these purposes.
- 13.2 The inspections and tests may be conducted on the premises of the SELLER or his sub-contractor(s), at point of DELIVERY and/or at the GOODS' final destination, when conducted on the premises of the SELLER or his sub-contractor(s), all reasonable facilities and

=====

assistance including access to the drawings and production data shall be furnished to the inspectors at no charge to the PURCHASER

- 13.3 Should any inspected or tested GOODS fail to conform to the specifications, the PURCHASER may reject them and the SELLER shall either replace the rejected GOODS or make all alterations necessary to meet Specifications' requirements, free of cost to the PURCHASER.
- 13.4 The PURCHASER's right to inspect, test and where necessary reject the GOODS after the GOODS' arrival in the PURCHASER's country shall in no way be limited or waived by reason of the GOODS having previously been inspected, tested and passed by the PURCHASER, or their representative prior to the GOODS shipment from the country of origin.
- 13.5 The INSPECTOR shall follow the progress of the manufacture of the GOODS under the CONTRACT to ensure that the requirements outlined in the CONTRACT are not being deviated with respect to schedule and quality.
- 13.6 SELLER shall allow the INSPECTOR to visit, during working hours, the workshops relevant for execution of the CONTRACT during the entire period of CONTRACT validity.
- 13.7 In order to enable PURCHASER's representatives to obtain entry visas in time, SELLER shall notify PURCHASER two months before assembly, testing and packing of main EQUIPMENT. If requested, SELLER shall assist PURCHASER's representatives in getting visas in the shortest possible time (applicable only in case of foreign order).
- 13.8 SELLER shall place at the disposal of the INSPECTOR, free of charge, all tools, instruments, and other apparatus necessary for the inspection and/or testing of the GOODS. The INSPECTOR is entitled to prohibit the use and dispatch of GOODS and/or materials which have failed to comply with the characteristics required for the GOODS during tests and inspections.
- 13.9 SELLER shall advise in writing of any delay in the inspection program at the earliest, describing in detail the reasons for the delay and the proposed corrective action.
- 13.10 ALL TESTS and trials in general, including those to be carried out for materials not manufactured by SELLER shall be witnessed by the INSPECTOR. Therefore, the SELLER shall confirm to PURCHASER by fax or e-mail the exact date of inspection with at least 30 days' notice. The seller shall specify the GOODS and quantities ready for testing and indicate whether a preliminary or final test is to be carried out.
- 13.11 If on receipt of this notice, the PURCHASER should waive the right to witness the test, timely information will be given accordingly.
- 13.12 Any and all expenses incurred in connection with tests, preparation of reports and analysis made by qualified laboratories, necessary technical documents, testing documents and drawings shall be at the SELLER's cost. The technical documents shall include the reference and numbers of the standards used in the construction and, wherever deemed practical by the INSPECTOR, copy such standards.
- 13.13 Nothing in Article-13 shall in any way release the SELLER from any warrantee or other obligations under this CONTRACT.

=====

13.14 Arrangements for all inspections required by Indian Statutory Authorities and as specified in technical specifications shall be made by SELLER.

13.15 **Inspection & Rejection of Materials by consignees:** When materials are rejected by the consignee, the supplier shall be intimated with the details of such rejected materials, as well as the reasons for their rejection, also giving location where such materials are lying at the risk and cost of the contractor/supplier. The supplier will be called upon either to remove the materials or to give instructions as to their disposal within 14 days and in the case of dangerous, infected and perishable materials within 48 hours, failing which the consignee will either return the materials to the contractor freight to pay or otherwise dispose them off at the contractor's risk and cost. The PURCHASER shall also be entitled to recover handling and storage charges for the period, during which the rejected materials are not removed @ 5% of the value of materials for each month or part of a month till the rejected materials are finally disposed off.

## 14. Time schedule & Progress Reporting:

### 14.1 Time Schedule Network/Bar Chart

14.1.1 Together with the Contract confirmation, the SELLER shall submit to PURCHASER his time schedule regarding the documentation, manufacture, testing, supply, erection and commissioning of the GOODS.

14.1.2 The time schedule will be in the form of a network or a bar chart clearly indicating all main or key events regarding documentation, supply of raw materials, manufacturing, testing, delivery, erection and commissioning.

14.1.3 The original issue and subsequent revisions of the SELLER's time schedule shall be sent to PURCHASER.

14.1.4 The time schedule network/bar chart shall be updated at least every second month.

### 14.2 Progress Trend Chart/Monthly Report

14.2.1 SELLER shall report monthly to PURCHASER, on the progress of the execution of CONTRACT and achievement of targets set out in time bar chart.

14.2.2 Progress will be expressed in percentages as shown in the progress trend chart attached to the Time Schedule specification.

14.2.3 The first issue of the Progress Trend Chart will be forwarded together with the time bar chart along with CONTRACT confirmation.

14.3 The PURCHASER's/CONSULTANT's representatives shall have the right to inspect SELLER's premises with a view to evaluating the actual progress of work on the basis of SELLER's time schedule documentation.

Irrespective of such inspection, SELLER shall advise CONSULTANT, with copy to PURCHASER, at the earliest possible date of any anticipated delay in the progress.

=====  
14.4 Notwithstanding the above, in case progress on the execution of contract at various stages is not as per phased time schedule and is not satisfactory in the opinion of the PURCHASER/CONSULTANT which shall be conclusive or SELLER shall neglect to execute the CONTRACT with due diligence and expedition or shall contravene the provisions of the CONTRACT, PURCHASER/CONSULTANT may give notice of the same in writing to the SELLER calling upon him to make good the failure, neglect or contravention complained of. Should SELLER fail to comply with such notice within the period considered reasonable by PURCHASER/CONSULTANT, the PURCHASER/CONSULTANT shall have the option and be at liberty to take the CONTRACT wholly or in part out of the SELLER's hand and make alternative arrangements to obtain the requirements and completion of CONTRACT at the SELLER's risk and cost and recover from the SELLER, all extra cost incurred by the PURCHASER on this account. In such event PURCHASER/CONSULTANT shall not be responsible for any loss that the SELLER may incur and SELLER shall not be entitled to any gain. The PURCHASER/CONSULTANT shall, in addition, have the right to encase Performance Guarantee in full or part.

## 15. Delivery & Documents:

15.1 Delivery of the GOODS shall be made by the SELLER in accordance with terms specified in the CONTRACT, and the goods shall remain at the risk of the SELLER until delivery has been completed.

15.2 Delivery shall be deemed to have been made:

- a) In the case of FOB, CFR & CIF Contracts, when the Goods have been put on board the ship, at the specified port of loading and a clean Bill of Lading is obtained. The date of Bill of Lading shall be considered as the delivery date.
- b) In case of FOT despatch point contract (For Indian bidder), on evidence that the goods have been loaded on the carrier and a negotiable copy of the GOODS receipt obtained. The date of LR/GR shall be considered as the date of delivery.
- c) In case of FOT site (for Indian bidders) on receipt of goods by PURCHASER/Consultant at the designated site(s).

15.3 The delivery terms are binding and essential and consequently, no delay is allowed without the written approval of PURCHASER/CONSULTANT. Any request concerning delay will be void unless accepted by PURCHASER/CONSULTANT through a modification to the CONTRACT.

15.4 Delivery time shall include time for submission of drawings for approval, incorporation of comments, if any, and final approval of drawings by PURCHASER/CONSULTANT.

15.5 In the event of delay in delivery, Price Reduction Schedule as stipulated in Article – 26 shall apply.

15.6 The documentation, in English Language, shall be delivered in due time, in proper form and in the required number of copies as specified in the contract.

15.7 Additional copies of final drawings and instructions will be included in the package of goods, properly enveloped and protected.

=====

15.8 The SELLER should comply with the Packing, Marking and Shipping Documentation Specifications enclosed.

## **16. Transit Risk Insurance:**

16.1 All goods supplied under the contract shall be fully insured in a freely convertible currency against loss or damage incidental to manufacture or acquisition, transportation, storage and delivery.

16.2 Where delivery is on FOB or CFR basis, marine insurance shall be the responsibility of the Purchaser. Insurance Requirements:

Indigenous Bidders: Transit risk insurance from F.O.T. despatch point onwards shall be arranged and borne by Seller.

Foreign Bidders: Marine insurance as well as transit insurance in Purchaser's country shall be arranged and borne by Seller.

The SELLER shall ensure that in effecting despatch of materials, the primary responsibility of the carriers for safe movement is always retained so that the PURCHASER's interests are fully safeguarded and are in no way jeopardised. The Seller shall furnish the cost of materials against each equipment.

16.3 PURCHASER's Insurance Agent:  
[The name and address-as mentioned under SCC] (if applicable)

## **17. Transportation**

17.1 Where the SELLER is required under the CONTRACT to deliver the GOODS FOB, transport of the GOODS until delivery, that is, upto and including the point of putting the GOODS on board the export conveyance at the specified port of loading, shall be arranged and paid for by the SELLER and the cost thereof shall be included in the Contract price.

17.2 Where the SELLER is required under the CONTRACT to deliver the GOODS CFR or CIF, transport of the Goods to the port of discharge or such other point in the country of destination as shall be specified in the CONTRACT shall be arranged and paid for by the SELLER and the cost thereof shall be included in the Contract price.

## **18. Incidental Services:**

18.1 The Seller may be required to provide any or all of the following services:

18.1.1 Performance or supervision of onsite assembly and/or start-up of the supplied Goods:

18.1.2 Furnishing tools required for assembly and/or maintenance of the supplied Goods:

18.1.3 Performance or supervision or maintenance and/or repair of the supplied Goods, for a period of time agreed by the parties, provided that this service shall not relieve the Seller of any warranty/guarantee obligations under the Contract.

- =====
- 18.1.4 Training of the Purchaser's personnel at the Seller's plant and/or at Site, in assembly, start-up operation, maintenance and/or repair of the supplied Goods at no extra cost. However, Purchaser will bear boarding, lodging & personal expenses of Trainees.
  - 18.2 Prices charged by the Seller for the preceding incidental services, shall not exceed the prevailing rates charged to other parties by the Seller for similar services.
  - 18.3 When required, Seller shall depute necessary personnel for supervision and/or erection of the Equipment at site for duration to be specified by Purchaser on mutually agreed terms. Seller's personnel shall be available at Site within seven days for emergency action and twenty- one days for medium and long-term assistance, from the date of notice given by Purchaser.
  - 18.4 If the cost of incidental Services is not shown separately in the Prices Schedule / Schedule of Rates, then the same shall be considered included in the quoted prices.

## **19. Spare Parts, Maintenance Tools, Lubricants:**

- 19.1 Seller may be required to provide any or all of the following materials and notification pertaining to spare parts manufactured or distributed by the Seller.
  - 19.1.1 Such spare parts as the Purchaser may opt to purchase from the Seller, provided that his option shall not relieve the Seller of any warranty obligations under the Contract, and
  - 19.1.2 In the event of termination of production of the spare parts:
    - i) Advance notification to the Purchaser of the pending termination, in sufficient time to permit the Purchaser to procure needed requirements, and
    - ii) Following such termination, furnishing at no cost to the Purchaser, the prints, drawings and specifications of the spare parts, if any when requested.
- 19.2 Seller shall supply item wise list with value of each item of spare parts and maintenance tools requirements, along with full details of manufacturers/vendors for such spares/maintenance tools for:
  - 19.2.1 The construction, execution and commissioning.
  - 19.2.2 Two years operation and maintenance.
- 19.3 Spare parts shall be new and of first-class quality as per engineering standards/ codes, free of any defects (even concealed), deficiency in design, materials and workmanship and also shall be completely interchangeable with the corresponding parts.
- 19.4 Type and sizes of bearings shall be clearly indicated.
- 19.5 Spare parts shall be packed for long storage under tropical climatic conditions in suitable cases, clearly marked as to intended purpose.

=====

19.6 A list of special tools and gauges required for normal maintenance and special handling and lifting appliances, if any, for the Goods shall be submitted to Purchaser.

19.7 Bidders should note that if they do not comply with Clause 19.2 above, their quotation may be rejected.

19.8 Lubricants

19.8.1 Whenever lubricants are required, Seller shall indicate the quantity of lubricants required for the first filling, the frequency of changing, the quantity of lubricants required for the one year's continuous operation and the types of recommended lubricants indicating the commercial name (trade-mark), quality and grade.

19.8.2 If Seller is unable to recommend specific oil, basic recommended characteristics of the lubricants shall be given.

19.8.3 Seller shall indicate various equivalent lubricants available in India.

## 20. Guarantee

20.1 All Goods or Materials shall be supplied strictly in accordance with the specifications, drawings, data sheets, other attachments and conditions stated in the Contract.

No deviation from such specifications or alterations or of these conditions shall be made without PURCHASER'S /CONSULTANT'S agreement in writing which must be obtained before any work against the order is commenced. All materials supplied by the SELLER pursuant to the Contract (irrespective of whether engineering, design data or other information has been furnished, reviewed or approved by PURCHASER/CONSULTANT) are guaranteed to be of the best quality of their respective kinds (unless otherwise specifically authorized in writing by PURCHASER/CONSULTANT) and shall be free from faulty design, workmanship and materials, and to be of sufficient size and capacity and of proper materials so as to fulfil in all respects all operating conditions, if any, specified in the Contract.

If any trouble or defect, originating with the design, material, workmanship or operating characteristics of any materials, arises at any time prior to twelve(12) months from the date of the first commercial operation of the Plant for which the materials supplied under the Contract form a part thereof, or twenty four (24) months from the date of last shipment whichever period shall first expire, and the SELLER is notified thereof, SELLER shall, at his own expense and as promptly as possible, make such alterations, repairs and replacements as may necessary to permit the materials to function in accordance with the specifications and to fulfil the foregoing guarantees.

PURCHASER/CONSULTANT may, at his option, remove such defective materials, at SELLER'S expense in which event SELLER shall, without cost to PURCHASER/CONSULTANT and as promptly as possible, furnish and install proper materials. Repaired or replaced materials shall be similarly guaranteed by the SELLER for a period of no less than twelve (12) months from the date of replacement/repair.

In the event that the materials supplied do not meet the specifications and/or not in accordance with the drawings data sheets or the terms of the Contract and rectification is

=====

required at site, PURCHASER/ CONSULTANT shall notify the SELLER giving full details of differences. The SELLER shall attend the site within seven (7) days of receipt of such notice to meet and agree with representatives of PURCHASER/ CONSULTANT, the action required to correct the deficiency. Should the SELLER fail to attend meeting at Site within the time specified above, PURCHASER/ CONSULTANT shall immediately rectify the work/ materials and SELLER shall reimburse PURCHASER all costs and expenses incurred in connection with such trouble or defect.

## 20.2 PERFORMANCE GUARANTEE OF EQUIPMENT

20.2.1 SELLER shall guarantee that the performance of the EQUIPMENT supplied under the CONTRACT shall be strictly in conformity with the specifications and shall perform the duties specified under the CONTRACT.

20.2.2 If the SELLER fails to prove the guaranteed performance of the EQUIPMENT set forth in the specification, the SELLER shall investigate the causes and carry out necessary rectifications/modifications to achieve the guaranteed performance. In case the SELLER fails to do so within a reasonable period, the SELLER shall replace the EQUIPMENT and prove guaranteed performance of the new equipment without any extra cost to PURCHASER.

20.2.3 If the SELLER fails to prove the guarantee within a reasonable period, PURCHASER/CONSULTANT shall have the option to take over the EQUIPMENT and rectify, if possible, the EQUIPMENT to fulfil the guarantees and/or to make necessary additions to make up the deficiency at Seller's risk and cost. All expenditure incurred by the PURCHASER/ CONSULTANT in this regard shall be to the SELLER's account.

## 21. Terms of Payment:

21.1 The method of payment to be made to the SELLER under this CONTRACT shall be specified in the Special Conditions of the Contract.

21.2 The type(s) of payment to be made to the SELLER under this CONTRACT shall be specified in the Special Conditions of Contract.

21.3 The SELLER's request(s) for payment shall be made to the PURCHASER in writing accompanied by an invoice describing, as appropriate, the Goods delivered and services performed, and by shipping documents submitted, and upon fulfilment of other obligations stipulated in the Contract.

21.4 Payment will be made in the currency or currencies in which the Contract Price has been stated in the SELLER's bid, as well as in other currencies in which the SELLER had indicated in his bid that he intends to incur expenditure in the performance of the Contract and wishes to be paid. If the requirements are stated as a percentage of the bid price along with exchange rates used in such these exchange rates shall be maintained.

### General Notes:

i) All foreign currency payments to foreign bidder shall be released through an irrevocable Letter of Credit, which shall be opened through Government of India

=====

Nationalised Bank and hence shall not be confirmed. In case any bidder insists on confirmation, charges towards confirmation shall be borne by him. L/C shall be established within 30 days after receipt of unconditional acceptance of Letter/Fax of Intent together with Performance Guarantee for 10% of total order/Contract value.

- ii) For dispatches on FOT dispatch point (in India) basis, the payment shall be through PURCHASER's bank. Payment through Bank, wherever applicable, shall be released as per normal banking procedures.
- iii) Payment shall be released within 30 days after receipt of relevant documents complete in all respects.
- iv) All bank charges incurred in connection with payments shall be to Seller's account in case of Indian bidders and to respective accounts in case of foreign bidder.
- v) Unless otherwise specifically stated in the bid document, all payments shall be made in the currency quoted.
- vi) No interest charges for delay in payments, if any, shall be payable by PURCHASER.
- vii) In case of Indian bidder, variation, if any, on account of customs duty on their built-in-import content, as per terms of bid document, shall be claimed separately by bidder after receipt of goods at site(s). However, any price benefits to the PURCHASER, on account of such variation as per terms specified in the bid document, shall be passed on to the PURCHASER along with invoicing itself.
- viii) Agency commission, if any, to Indian agent for foreign bidders, indicated in prices, shall be paid to the agent in equivalent Indian Rupees on receipt and acceptance of material at site.

## **22. Prices:**

- 22.1 Prices charged by the SELLER for Goods delivered and services performed under the CONTRACT shall not, with the exception of any price adjustments authorized by the Contract vary from the prices quoted by the SELLER in his bid.

## **23. Subletting & Assignment:**

- 23.1 The contractor shall not without previous consent in the writing of the PURCHASER authority, sublet, transfer or assign the contract or any part thereof or interest therein or benefit or advantage thereof in any manner whatsoever. Provided, nevertheless, that any such consent shall not relieve the contractor from any obligation, duty or responsibility under the contract.

## **24. Time as Essence of Contract:**

- 24.1 The time and date of delivery/completion of the GOODS/SERVICES as stipulated in the Contract shall be deemed to be the essence of the Contract.

=====

## 25. Delays in the Seller's Performance:

- 25.1 If the specified delivery schedule is not adhered to or the progress of manufacture or supply of the items is not satisfactory or is not in accordance with the progress schedule the PURCHASER has the right to:
- i) hire for period of delay from elsewhere goods which in PURCHASER's opinion will meet the same purpose as the goods which are delayed, and SELLER shall be liable without limitation for the hire charges; or
  - ii) cancel the CONTRACT in whole or in part without liability for cancellation charges. In that event, PURCHASER may procure from elsewhere goods which PURCHASER's opinion would meet the same purpose as the goods for which CONTRACT is cancelled and SELLER shall be liable without limitations for the difference between the cost of such substitution and the price set forth in the CONTRACT for the goods involved; or
  - iii) hire the substitute goods vide (i) above and if the ordered goods continue to remain undelivered thereafter, cancel the order in part or in full vide (ii) above.
- 25.2 Any inexcusable delay by the SELLER or his sub-contractor shall render the SELLER liable, without prejudice to any other terms of the Contract, to any or all of the following sanctions: forfeiture of Contract performance guarantee, imposition of price reduction for delay in delivery and termination of the contract for default.

## 26. Price Reduction Schedule for Delayed Delivery:

- 26.1 Subject to Article -29, if the SELLER fails to deliver any or all of the GOODS or performance the services within the time period (s) specified in the CONTRACT, the PURCHASER shall, without prejudice to his other remedies under the CONTRACT, deduct from the CONTRACT PRICE, a sum calculated on the basis of the CONTRACT PRICE, including subsequent modifications.

26.1.1 Deductions shall apply as per following formula:

If a portion of supply completed in all respect within the contractual delivery period and which can be used for commercial operation, the PRS shall be applicable only on remaining supplies which are completed beyond the contractual delivery period, @½ % (half percent) of the delayed delivery value maximum upto 5% (five percent) of the total Executed Contract Value.

- 26.2 In case of delay in delivery on the part of Seller, the invoice/document value shall be reduced proportionately for the delay and payment shall be released accordingly.
- 26.3 In the event the invoice value is not reduced proportionately for the delay, the PURCHASER may deduct the amount so payable by SELLER, from any amount falling due to the SELLER or by recovery against the Performance Guarantee. Both seller and PURCHASER agree the above percentages of price reduction are genuine pre estimates of the loss/damage which the PURCHASER would have suffered on account of delay/breach on the part of the SELLER and the said amount will be payable on demand without there being any proof of the actual

=====

loss/or damage caused by such breach/delay. A decision of the PURCHASER in the matter of applicability of price reduction shall be final and binding.

## **27. Rejections, Removal of Rejected Equipment & Replacement**

- 27.1 Preliminary inspection at SELLER's works by INSPECTOR shall not prejudice PURCHASER's/CONSULTANT's claim for rejection of the EQUIPMENT on final inspection at SITE or claims under warranty provisions.
- 27.2 If the EQUIPMENTS are not of specification or fail to perform specified duties or are otherwise not satisfactory the PURCHASER/CONSULTANT shall be entitled to reject the EQUIPMENT/MATERIAL or part thereof and ask free replacement within reasonable time failing which obtain his requirements from elsewhere at SELLER's cost and risk.
- 27.3 Nothing in this clause shall be deemed to deprive the PURCHASER AND/OR AFFECT ANY rights under the Contract which it may otherwise have in respect of such defects or deficiencies or in any way relieve the SELLER of his obligations under the Contract.
- 27.4 EQUIPMENT rejected by the PURCHASER/CONSULTANT shall be removed by the Seller at his cost within 14 days of notice after repaying the amounts received against the SUPPLY. The PURCHASER shall in no way be responsible for any deterioration or damage to the EQUIPMENT under any circumstances whatsoever.
- 27.5 In case of rejection of EQUIPMENT, PURCHASER shall have the right to recover the amounts, if any, from any of CONTRACTOR'S invoices pending with PURCHASER or by alternative method(s).

## **28. Termination of Contract:**

- 28.1 Termination for Default
- 28.1.1 The PURCHASER may, without prejudice to any other remedy for breach of CONTRACT, by written notice of default sent to the SELLER, terminate the CONTRACT in whole or in part:
- A) If the SELLER fails to deliver any or all of the GOODS within the time period(s) specified in the CONTRACT; or
  - B) If the SELLER fails to perform any other obligation(s) under the CONTRACT, and
  - C) If the SELLER, in either of the above circumstances, does not cure his failure within a period of 30 days (or such longer period as the PURCHASER may authorize in writing) after receipt of the default notice from the PURCHASER.
- 28.1.2 In the event the PURCHASER terminates the CONTRACT in whole or in part, pursuant to Article 28.1.1, the PURCHASER may procure, upon such terms and in such manner as it deems appropriate, goods similar to those undelivered and the SELLER shall be liable to the PURCHASER for any excess costs for such similar

=====

GOODS. However, the SELLER shall continue performance of the CONTRACT to the extent not terminated.

28.1.3 In case of termination of CONTRACT herein set forth (under clause 28) except under conditions of Force Majeure and termination after expiry of contract, the VENDOR shall be put under holiday [i.e. neither any enquiry will be issued to the party by IGGL. Against any type of tender nor their offer will be considered by IGGL against any ongoing tender (s) where contract between IGGL and that particular VENDOR (as a bidder) has not been finalized] for three years from the date of termination by IGGL to such VENDOR.

28.2 Termination for Insolvency

28.2.1 The PURCHASER, may at any time, terminate the CONTRACT by giving written notice to the SELLER, without compensation to the SELLER, if the SELLER becomes bankrupt or otherwise insolvent, provided that such termination will not prejudice or affect any right of action or which has accrued or will accrue thereafter to the PURCHASER

28.3 Termination for Convenience

28.3.1 The PURCHASER may, by written notice sent to the SELLER, terminate the CONTRACT, in whole or part, at any time for his convenience. The notice of termination shall specify that termination is for the PURCHASER's convenience, the extent to which performance of work under the CONTRACT is terminated and the date upon which such termination becomes effective.

28.3.2 The GOODS that are complete and ready for shipment within 30 days after the SELLER's receipt of notice of termination shall be purchased by the PURCHASER at the CONTRACT terms and prices. For the remaining GOODS, the PURCHASER may opt:

- a) to have any portion completed and delivered at the CONTRACT terms and prices, and /or
- b) to cancel the remainder and pay to the SELLER an agreed amount for partially completed GOODS and for materials and parts previously procured by the SELLER.

**29. Force Majeure:**

29.1 Shall mean and be limited to the following:

- a) War/hostilities
- b) Riot or Civil commotion
- c) Earthquake, flood, tempest, lightening or other natural physical disaster.
- d) Restrictions imposed by the Government or other Statutory bodies which prevents or delays the execution of the Contract by the SELLER.

The SELLER shall advise PURCHASER/ CONSULTANT by a registered letter duly certified by the local Chamber of Commerce or statutory authorities, the beginning and end of the

=====

above causes of delay within seven (7) days of the occurrence and cessation of such Force Majeure Conditions. In the event of delay lasting over one month, if arising out of causes of Force Majeure, PURCHASER/CONSULTANT reserves the right to cancel the Contract and the provisions governing termination stated under Article 28.0 shall apply.

For delays arising out of Force Majeure, the SELLER shall not claim extension in completion date for a period exceeding the period of delay attributable to the causes of Force Majeure and neither PURCHASER/CONSULTANT nor SELLER shall be liable to pay extra costs provided it is mutually established that Force Majeure Conditions did actually exist.

SELLER shall categorically specify the extent of Force Majeure Conditions prevalent in their works at the time of submitting their bid and whether the same have been taken into consideration or not in their quotations. In the event of any force majeure cause, the SELLER or the PURCHASER shall not be liable for delays in performing their obligations under this order and the delivery dates will be extended to the SELLER without being subject to price reduction for delayed deliveries, as stated elsewhere.

### **30. Resolution of Disputes / Arbitration:**

30.1 The PURCHASER and the SELLER shall make every effort to resolve amicably by direct informal negotiations any disagreement or dispute arising between them under or in connection with the contract.

30.2 If, after thirty days from the commencement of such informal negotiations, the PURCHASER and the SELLER have been unable to resolve amicably a Contract dispute, either party may require that the dispute be referred for resolution to the formal mechanism as specified hereunder.

30.3 Legal Construction

The Contract shall be, in all respects be construed and operated as an Indian Contract and in accordance with Indian Laws as in force for the time being and is subject to and referred to the Court of Law situated within Guwahati.

30.4 Arbitration

All disputes, controversies, or claims between the parties (except in matters where the decision of the Engineer-in-Charge is deemed to be final and binding) which cannot be mutually resolved within a reasonable time shall be referred to Arbitration by a sole arbitrator. The PURCHASER IGGL shall suggest a panel of three independent and distinguished persons to the Seller to select any one among them to act as the sole Arbitrator.

In the event of failure of the Seller to select the Sole Arbitrator within 30 days from the receipt of the communication suggesting the panel of arbitrators, the right of selection of Sole Arbitrator by the other party shall stand forfeited and the PURCHASER shall have discretion to proceed with the appointment of the Sole Arbitrator. The decision of the PURCHASER on the appointment of Sole Arbitrator shall be final and binding on the parties.

The award of Sole Arbitrator shall be final and binding on the parties unless directed/awarded otherwise by the Sole Arbitrator, the cost of arbitration proceedings shall

=====

be shared equally by the parties. The arbitration proceeding shall be in English language and the venue shall be Guwahati, Assam, India.

Subject to the above, the provisions of (Indian) Arbitration & Conciliation Act, 1996 and the rules framed thereunder shall be applicable. All matters relating to this contract are subject to the exclusive jurisdiction of the Courts situated in the Guwahati, Assam (India).

Seller may please note that the Arbitration & Conciliation Act 1996 was enacted by the Indian Parliament and is based on United nations Commission on International Trade Law (UNCITRAL model law), which were prepared after extensive consultation with Arbitral Institutions and centers of International Commercial Arbitration. The United Nations General Assembly vide resolution 31/98 adopted the UNCITRAL Arbitration rules on 15 December 1996.

The WORK under the CONTRACT shall, however, continue during the Arbitration proceedings and no payment due or payable to the Seller shall be withheld on account of such proceedings.

## **31. Governing Language**

31.1 The Contract shall be written in English language as specified by the PURCHASER/CONSULTANT in the Instruction to Bidders. All literature, correspondence and other documents pertaining to the Contract which are exchanged by the parties shall be written in English language. Printed literature in other language shall only be considered, if it is accompanied by an English translation. For the purposes of interpretation, English translation shall govern and be binding on all parties.

## **32. Notices**

32.1 Any notice given by one party to the other pursuant to the Contract shall be sent in writing or by telegram or fax, telex/cable confirmed in writing.

32.2 A notice shall be effective when delivered or on the notice's effective date, whichever is later.

## **33. Taxes & Duties**

33.1 A foreign shall be entirely responsible for all taxes, stamp duties, license fees, and other such levies imposed outside the PURCHASER's country.

33.2 A domestic Seller shall be entirely responsible for all taxes, duties, license fees etc. incurred until the delivery of the contracted goods to the PURCHASER. However, Sales Tax and Excise duty on finished products shall be reimbursed by PURCHASER.

33.3 Customs duty payable in India for imported goods ordered by PURCHASER on foreign Seller shall be borne and paid by PURCHASER.

33.4 Any income tax payable in respect of supervisory services rendered by foreign Seller under the Contract shall be as per the Indian Income Tax Act and shall be borne by SELLER. It is upto the bidder/seller to ascertain the amount of these taxes and to include them in his bid price.

=====

## 34. Books & Records

34.1 SELLER shall maintain adequate books and records in connection with Contract and shall make them available for inspection and audit by PURCHASER/ CONSULTANT or their authorized agents or representatives during the terms of Contract until expiry of the performance guarantee. Fixed price (lumpsum or unit price) Contract will not be subject to audit as to cost except for cost reimbursable items, such as escalation and termination claims, transportation and comparable requirements.

## 35. Permits & Certificates:

35.1 SELLER shall procure, at his expense, all necessary permits, certificates and licences required by virtue of all applicable laws, regulations, ordinances and other rules in effect at the place where any of the work is to be performed, and SELLER further agrees to hold PURCHASER and/or CONSULTANT harmless from liability or penalty which might be imposed by reason of any asserted or established violation of such laws, regulations, ordinances or other rules. PURCHASER will provide necessary permits for SELLER's personnel to undertake any work in India in connection with Contract.

## 36. General

36.1 In the event that terms and conditions stipulated in the General Conditions of Contract should deviate from terms and conditions stipulated in the Contract, the latter shall prevail.

36.2 Losses due to non-compliance of Instructions

Losses or damages occurring to the PURCHASER owing to the SELLER's failure to adhere to any of the instructions given by the PURCHASER/CONSULTANT in connection with the contract execution shall be recoverable from the SELLER.

36.3 Recovery of sums due

All costs, damages or expenses which the PURCHASER/CONSULTANT may have paid, for which under the CONTRACT SELLER is liable, may be recovered by the PURCHASER (he is hereby irrevocably authorized to do so) from any money due to or becoming due to the SELLER under this Contract or other Contracts and/or be recovered by action at law or otherwise. If the same due to the SELLER be not sufficient to recover the recoverable amount, the SELLER shall pay to the PURCHASER, on demand, the balance amount.

36.4 Payments, etc. not to affect rights of the PURCHASER No sum paid on account by the PURCHASER nor any extension of the date for completion granted by the PURCHASER/CONSULTANT shall affect or prejudice the rights of the PURCHASER against the SELLER or relieve the SELLER of his obligation for the due fulfilment of the CONTRACT.

36.5 Cut-off Dates

No claims or correspondence on this contract shall be entertained by the PURCHASER/Consultant after 90 days after expiry of the performance guarantee (from the date of final extension, if any).

36.6 Paragraph heading

The paragraph heading in these conditions shall not affect the construction thereof.

=====

## 37. Import License:

37.1 No import license is required for the imports covered under this document.

## 38. Fall Clause:

38.1 The price charged for the materials supplied under the order by the supplier shall in no event exceed the lowest price at which the supplier or his agent/principal/dealer, as the case may be, sells the materials of identical description to any Persons/Organizations including the Purchaser or any Department of the Central Govt. or any Department of a State Govt. or any Statutory Undertaking of the Central or State Govt. as the case may be, during the currency of the order.

38.2 If at any time during the said period, the supplier or his agent/principal/dealer, as the case may be, reduces the sale price, sells or offers to sell such materials to any persons/organizations including the Purchaser or any Deptt. Of Central Govt. or State Govt. as the case may be, at a price lower than the price chargeable under the order, he shall forthwith notify such reduction or sale or offer of sale to the Purchase Authority who has issued this order and the price payable under the order for the materials supplied after the date of coming into force of such reduction or sale or offer of sale shall stand correspondingly reduced.

The above stipulation will, however, not apply to:

- a) Export/Deemed Export by the supplier;
- b) Sale of goods as original equipment at prices lower than the prices charged for normal replacement
- c) Sale of goods such as drugs which have expiry dates.
- d) Sale of goods at lower price on or after the date of completion of sale / placement of order of goods by the authority concerned, under the existing or previous Rate Contracts as also under any previous contracts entered into with the Central or State Government Departments including new undertakings (excluding joint sector companies or private parties) and bodies.

38.3 The supplier shall furnish the following certificate to the concerned Paying Authority along with each bill for payment for supplies made against this order: -

"I/We certify that there has been no reduction in sale price of the items/goods/materials of description identical to those supplied to the IGGL under the order herein and such items/goods/materials have not been offered/sold by me/us to any person/organizations including the Purchaser or any Deptt. of Central Govt. or any Deptt. of State Govt. or any Statutory Undertaking of the Central or State Govt. as the case may be upto the date of bill/during the currency of the order whichever is later, at a price lower than the price charged to the IGGL under the order".

Such a certificate shall be obtained, except for quantity of items/goods/materials categories under sub-clause (a), (b), (c) & (d) of sub-para 38.2 above, of which details shall be furnished by the supplier.

=====

**39. Publicity & Advertising:**

39.1 Seller shall not without the written permission of PURCHASER/CONSULTANT make a reference to PURCHASER/CONSULTANT or any Company affiliated with PURCHASER/CONSULTANT or to the destination or the description of goods or services supplied under the contract in any publication, publicity or advertising media.

**40. Repeat Order:**

40.1 PURCHASER reserves the right, within 06 (Six) months of order, to place repeat order upto 25% of the total order value without any change in unit price or other terms and conditions.

**41. Limitation of Liability:**

41.1 Notwithstanding anything contrary contained herein, the aggregate total liability of Seller under the Agreement or otherwise shall be limited to 100% of Agreement / Order price. However, neither party shall be liable to the other party for any indirect and consequential damages, loss of profits or loss of production.

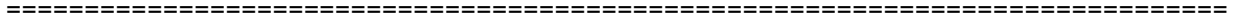

## SECTION-V

### FORMS & FORMATS

**LIST OF FORMS & FORMATS**

<b>Form No.</b>	<b>Description</b>
F-1	BIDDER'S GENERAL INFORMATION
F-2	PROFORMA OF "BANK GUARANTEE" FOR "EARNEST MONEY / BID SECURITY"
F-2A	PROFORMA OF DECLARATION FOR BID SECURITY
F-3	LETTER OF AUTHORITY
F-4	PROFORMA OF "BANK GUARANTEE" FOR "CONTRACT PERFORMANCE SECURITY / SECURITY DEPOSIT"
F-5	AGREED TERMS & CONDITIONS
F-6	ACKNOWLEDGEMENT CUM CONSENT LETTER
F-7	BIDDER'S EXPERIENCE
F-8	CHECK LIST
F-9	FORMAT FOR CERTIFICATE FROM BANK IF BIDDER'S WORKING CAPITAL IS INADEQUATE
F-10	FORMAT FOR CHARTERED ACCOUNTANT CERTIFICATE FOR FINANCIAL CAPABILITY OF THE BIDDER
F-11	BIDDER'S QUERIES FOR PRE-BID MEETING
F-12	E-BANKING FORMAT
F-13	FREQUENTLY ASKED QUESTIONS (FAQ)
F-14	UNDERTAKING REGARDING SUBMISSION OF ELECTRONIC INVOICE (E-INVOICE AS PER GST LAWS)
F-15	DECLARATION ON PROCEEDINGS UNDER INSOLVENCY AND BANKRUPTCY CODE 2016
F-16	FORMAT FOR NO CLAIM CERTIFICATE FOR RELEASE OF CPS/SECURITY DEPOSIT

=====

**F-1**

**BIDDER'S GENERAL INFORMATION**

To,  
M/s IGGL

**TENDER NO:** IGGL/GHY/C&P/PROJ/BALL-VALVE/04-26

1.	Bidder Name	
2.	Status of Firm	Proprietorship Firm / Partnership Firm / LLP Firm / Public Limited / Pvt. Limited / Govt. Dept. / PSU / Others If Others Specify: _____  [Enclose relevant certificates / partnership deed/certificate of Registration, as applicable]
3a.	Name of Proprietor / Partners / Directors of the firm/company [As per Cl. No. 4.0 of ITB]	1. 2. 3.
3b.	Name of Power of Attorney Holders of bidder	
4.	Number of Years in Operation	
5.	Address of Registered Office:	City:
		District:
		State:
		PIN/ZIP:
6.	Bidder's address where order/ contract is to be placed *	City:
		District:
		State:
		PIN/ZIP:
7.	Address from where Goods/ Services are to be dispatched/ provided along with GST no. (In case supply of Goods/ Services are from multiple locations, addresses and GST no. of all such locations are to be provided).	City:
		District:
		State:
		PIN/ZIP:
		GST No.:
8.	Telephone Number & Contact Information address where order is to be placed	_____ (Country Code) (Area Code) (Telephone No.)
9.	E-mail address	
10.	Website	
11.	Mobile Number:	

12.	ISO Certification, if any	{If yes, please furnish details}
13.	PAN No.	[Enclose copy of PAN Card]
14.	GST No. (refer sl. no. 7 above)	[Enclose copy of GST Certificate]
15.	Whether Micro or Small Enterprise	Yes/No (If Yes, Bidder to submit requisite documents as specified in ITB: Cl. No. 40)
	Whether MSE is owned by SC/ST Entrepreneur(s)	Yes/No (If Yes, Bidder to submit requisite documents as specified in ITB: Cl. No. 40)
	Whether MSE is owned by Women	Yes/No (If Yes, Bidder to submit requisite documents as specified in ITB: Cl. No. 40)
16.	Whether Bidder is Start-up or not	Yes / No (If Yes, Bidder to submit requisite documents as specified it ITB: Clause No.49)
	In case of Start-up confirm the following:  (i) Date of its incorporation/ registration [The certificate shall only be valid for the entity upto ten years from the date of its incorporation/ registration]  (ii) Whether turnover for any financial years since incorporation/ registration has exceed Rs.100 Crores.	

Note: \* IGGL intent to place the order/contract directly on the address from where Goods are produced/dispatched. In case, bidder wants order/ contract at some other address or supply of Goods from multiple locations, bidder is required to provide the address on which order is to be placed at sl. no. 6 above.

Place: [Signature of Authorized Signatory of Bidder]

Date: Name:

Designation:

Seal:

=====

**FORMAT F-2**  
**PROFORMA OF "BANK GUARANTEE"**  
**FOR "EARNEST MONEY / BID SECURITY"**  
 (To be stamped in accordance with the Stamp Act)

To, M/s Indradhanush Gas Grid Limited (IGGL)  -----  	<b>Bank Guarantee No.</b>	
	<b>Date of BG</b>	
	<b>BG Valid up to</b>	
	<b>Claim period up to (There should be three months gap between expiry date of BG &amp; Claim period)</b>	
	<b>Stamp Sl. No./e-Stamp Certificate No.</b>	

**Dear Sir(s),**

In accordance with Letter Inviting Tender under your reference No \_\_\_\_\_  
 M/s. \_\_\_\_\_ having their Registered / Head Office at \_\_\_\_\_ (hereinafter called the Tenderer),  
 wish to participate in the said tender for

As an irrevocable Bank Guarantee against Earnest Money for the amount of \_\_\_\_\_ is required to be submitted by the Tenderer as a condition precedent for participation in the said tender which amount is liable to be forfeited on the happening of any contingencies mentioned in the Tender Document.

We, the \_\_\_\_\_ Bank at \_\_\_\_\_ having our Head Office \_\_\_\_\_ (Local Address) guarantee and undertake to pay immediately on demand without any recourse to the tenderers by IGGL, the amount \_\_\_\_\_ without any reservation, protest, demur and recourse. Any such demand made by IGGL, shall be conclusive and binding on us irrespective of any dispute or difference raised by the Tenderer.

This guarantee shall be irrevocable and shall remain valid up to \_\_\_\_\_ [this date should be two (02) months beyond the validity of the bid]. If any further extension of this guarantee is required, the same shall be extended to such required period on receiving instructions from M/s. \_\_\_\_\_ whose behalf this guarantee is issued.

In witness whereof the Bank, through its authorized officer, has set its hand and stamp on this \_\_\_\_\_ day of \_\_\_\_\_ 20\_\_ at \_\_\_\_\_.

Notwithstanding anything contained herein:

- a) The Bank's liability under this Guarantee shall not exceed (currency in figures) ..... (currency in words only).....
- b) This Guarantee shall remain in force upto \_\_\_\_\_(this expiry date of BG should be two months beyond the validity of bid) and any extension(s) thereof; and
- c) The Bank shall be released and discharged from all liability under this Guarantee unless a written claim or demand is issued to the Bank on or before the midnight of .....(indicate date of expiry of claim period which includes minimum three months from the expiry of this Bank Guarantee) and if extended, the date of expiry of the last extension of this Guarantee. If a claim has been received by us within the said date, all the rights of IGGL under this Guarantee shall be valid and shall not cease until we have satisfied that claim.

=====

Details of next Higher Authority of the Officials who have issued the Bank Guarantee:

Name .....

Designation .....

WITNESS:

(SIGNATURE)

(SIGNATURE)

(NAME)

(NAME)

Designation with Bank Stamp

**(OFFICIAL ADDRESS)**

Attorney as per

Power of Attorney No. \_\_\_\_\_

Date: \_\_\_\_\_

-----

**INSTRUCTIONS FOR FURNISHING "BID SECURITY / EARNEST MONEY" BY "BANK GUARANTEE"**

1. The Bank Guarantee by Bidders will be given on non-judicial stamp paper as per "Stamp Duty" applicable. The non-judicial stamp paper should be in the name of the issuing Bank. In case of foreign Bank, the said Bank's Guarantee to be issued by its correspondent Bank in India on requisite non-judicial stamp paper.
2. The expiry date should be arrived at in accordance with "ITB: Clause-16.1".
3. The Bank Guarantee by bidders will be given from Bank as specified in "ITB" Clause-16.2"
4. A letter from the issuing Bank of the requisite Bank Guarantee confirming that said Bank Guarantee / all future communication relating to the Bank Guarantee shall be forwarded to the Employer at its address as mentioned at "ITB".
5. Bidders must indicate the full postal address of the Bank along with the Bank's E-mail / Fax / Phone from where the Earnest Money Bond has been issued as per proforma provided below:
6. If a Bank Guarantee is issued by a commercial Bank, then a letter to Employer confirming its net worth is more than Rs. 1,000,000,000.00 [Rupees One Hundred Crores] or equivalent along with documentary evidence OR in the Bank Guarantee itself.

**7. THE BANK GUARANTEE ISSUED BY THE BANK MUST BE ROUTED THROUGH SFMS PLATFORM AS PER FOLLOWING DETAILS:**

"BG issuance message (IFN 760 / IFN760COV For issuance of BG and IFN 767 / IFN 767 COV FOR Amendment of BG) is to be transmitted through SFMS to beneficiary's bank as below:

Name of Bank : Axis Bank  
 Branch : Guwahati  
 Branch Address : Chhibber House, Ground Floor, G.S Road, Guwahati -781005  
 IFSC : UTIB0000140  
 SWIFT Code : AXISINBB140

The issuing bank while issuing/amending the BG, should ensure that the below information is correctly captured in the message i.e., IFN 760 / IFN 760COV / IFN 767/ IFN 767COV:

Field Number	Particulars
7037	IGGL938956645

=====

NOTE: THE BANK GUARANTEE ISSUED BY THE BANK MUST BE ROUTED THROUGH SFMS PLATFORM AS PER FOLLOWING DETAILS:

- (i) IFN 760 / IFN 760COV FOR ISSUANCE OF BANK GUARANTEE
- (ii) IFN 767 / IFN 767 COV FOR AMENDMENT OF BANK GUARANTEE
- (iii) THE ABOVE MESSAGE / INTIMATION SHALL BE SENT THROUGH SFMS BY THE BG ISSUING BANK TO AXIS BANK, GUWAHATI BRANCH, IFSC CODE – UTIB0000140; BRANCH ADDRESS: Axis Bank, Chhibber House, Ground Floor, G.S Road, Guwahati - 781005
- (iv) THE SUPPLIER SHALL SUBMIT TO IGGL THE COPY OF SFMS MESSAGE AS SENT BY THE ISSUING BANK ALONG WITH THE ORIGINAL BANK GUARANTEE

-----XXXXXXXX-----

**MATTER TO BE MENTIONED IN COVERING LETTER TO BE SUBMITTED BY VENDOR ALONG WITH BANK GUARANTEE**

1	<b>BANK GUARANTEE NO</b>	:				
2	<b>VENDOR NAME / VENDOR CODE</b>	:	<b>NAME</b>			
			<b>VENDOR CODE</b>			
3	<b>BANK GUARANTEE AMOUNT</b>	:				
4	<b>TENDER NO.</b>	:				
5	<b>NATURE OF BANK GUARANTEE</b>	:				
	<b>(Please Tick (√) whichever is Applicable</b>		<b>PERFORMANCE BANK GUARANTEE</b>	<b>SECURITY DEPOSIT</b>	<b>EMD</b>	<b>ADVANCE</b>
6	<b>BG ISSUED BANK DETAILS</b>					
		(A)	<b>EMAIL ID:</b>			
		(B)	<b>ADDRESS:</b>			
		(C)	<b>PHONE NO.:</b>			

=====

**F-2A**

**DECLARATION FOR BID SECURITY**

**To,**

**M/s INDRADHANUSH GAS GRID LIMITED (IGGL)**

\_\_\_\_\_

**SUB:** PROCUREMENT OF BALL VALVE FOR BI- DIRECTIONAL FLOW ARRANGEMENT IN COMPRESSOR STATION, BAIHATA

**TENDER NO:** IGGL/GHY/C&P/PROJ/BALL-VALVE/04-26

Dear Sir,

After examining/reviewing provisions of above referred tender documents (including all corrigendum/Addenda), we M/s \_\_\_\_\_ (**Name of the bidder**) have submitted our offer/bid no. ....

We, M/s \_\_\_\_\_ (**Name of the bidder**) hereby understand that, according to your conditions, we are submitting this Declaration for Bid Security.

We understand that we will be put on watch list/ holiday/banning list (as per polices of INDRADHANUSH GAS GRID LIMITED (IGGL) in this regards), if we are in breach of our obligation(s) as per following:

- (a) have withdrawn/ modified/amended, impairs or derogates from the tender, my/ our Bid during the period of bid validity specified in the form of Bid, or
- (b) having been notified of the acceptance of our Bid by the INDRADHANUSH GAS GRID LIMITED (IGGL) during the period of Bid Validity:
  - i. fail of refuse to execute the contract, if required, or
  - ii. fail of refuse to furnish the contract performance security, in accordance provision of the tender document.
  - iii. fail or refuse to accept "arithmetical correction" as per provision of the tender document.
- (c) having indulged in corrupt/fraudulent/ collusive / coercive practice as per procedure.

Place:  
Date:

[Signature of Authorized Signatory of Bidder]  
Name:  
Designation:  
Seal:



=====

**F-3**  
**LETTER OF AUTHORITY**

[Pro forma for Letter of Authority for Attending 'Pre-Bid Meetings'/'Un-Priced Bid Opening'/'Price Bid Opening]

Ref:

Date:

To,  
M/s IGGL

**TENDER NO:** IGGL/GHY/C&P/PROJ/BALL-VALVE/04-26

**Dear Sir,**

I/We, \_\_\_\_\_ hereby authorize the following representative(s) for attending 'Pre-Bid Meeting', 'Unpriced Bid Opening, 'Price Bid Opening' against the above Tender Document:

[1] Name & Designation \_\_\_\_\_ Signature \_\_\_\_\_  
Phone/Cell:  
Fax:  
E-mail: ..... @ .....

[2] Name & Designation \_\_\_\_\_ Signature \_\_\_\_\_  
Phone/Cell:  
Fax:  
E-mail: ..... @ .....

We confirm that we shall be bound by all commitments made by aforementioned authorised representative(s).

Place: [Signature of Authorized Signatory of Bidder]  
Date: Name:  
Designation:  
Seal:

**Note:** This "Letter of Authority" should be on the "**letterhead**" of the Firm / Bidder and should be signed by a person competent and having the 'Power of Attorney' to bind the Bidder. Not more than 'two [02] persons per Bidder' are permitted to attend 'Pre-Bid Meetings' / 'Un-priced Bid Opening' / 'Price Bid Opening'. Bidders authorized representative is required to carry a copy of this authority letter while attending the 'Pre-Bid Meeting' / 'Un-priced Bid Opening' / 'Price Bid Opening'.

F-4

**PROFORMA OF "BANK GUARANTEE" FOR "CONTRACT PERFORMANCE SECURITY / SECURITY DEPOSIT"**

**(ON NON-JUDICIAL STAMP PAPER OF APPROPRIATE VALUE)**

To,  M/s Indradhanush Gas Grid Limited (IGGL)  -----	<b>Bank Guarantee No.</b>	
	<b>Date of BG</b>	
	<b>BG Valid up to</b>	
	<b>Claim period up to (indicate date of expiry of claim period which includes minimum three months from the expiry date)</b>	
	<b>Stamp Sl. No./e-Stamp Certificate No.</b>	

**Dear Sir(s),**

M/s. \_\_\_\_\_ having registered office at \_\_\_\_\_ (herein after called the "contractor/supplier" which expression shall wherever the context so require include its successors and assignees) have been placed/awarded the job/work of \_\_\_\_\_ vide PO/LOA/FOA No. \_\_\_\_\_ dated \_\_\_\_\_ for **Indradhanush Gas Grid Limited (IGGL)** having registered office at 7th Floor, 122A, NRL Centre, Christian Basti, G S Road, Guwahati, Assam-781005 (herein after called the "IGGL" which expression shall wherever the context so require includes its successors and assignees).

The Contract conditions provide that the SUPPLIER/CONTRACTOR shall pay a sum of Rs. \_\_\_\_\_ (Rupees \_\_\_\_\_) as full Contract Performance Guarantee in the form therein mentioned. The form of payment of Contract Performance Guarantee includes guarantee executed by Nationalized Bank/Scheduled Commercial Bank, undertaking full responsibility to indemnify IGGL, in case of default.

The said M/s \_\_\_\_\_ has approached us and at their request and in consideration of the premises we having our office at \_\_\_\_\_ have agreed to give such guarantee as hereinafter mentioned.

1. We \_\_\_\_\_ hereby undertake to give the irrevocable & unconditional guarantee to you that if default shall be made by M/s. \_\_\_\_\_ in performing any of the terms and conditions of the tender/order/contract or in payment of any money payable to IGGL we shall on first demand pay without demur, contest, protest and/ or without any recourse to the contractor to IGGL in such manner as IGGL may direct the said amount of Rupees \_\_\_\_\_ only or such portion thereof not exceeding the said sum as you may require from time to time.
2. You will have the full liberty without reference to us and without affecting this guarantee, postpone for any time or from time to time the exercise of any of the powers and rights conferred on you under the order/contract with the said M/s \_\_\_\_\_ and to enforce or to forbear from endorsing any powers or rights or by reason of time being given to the said M/s \_\_\_\_\_ and such postponement forbearance would not have the effect of releasing the bank from its obligation under this debt.

- =====
3. Your right to recover the said sum of Rs. \_\_\_\_\_ (Rupees \_\_\_\_\_) from us in manner aforesaid is absolute & unequivocal and will not be affected or suspended by reason of the fact that any dispute or disputes have been raised by the said M/s \_\_\_\_\_ and/or that any dispute or disputes are pending before any officer, tribunal or court or arbitrator or any other authority/forum and any demand made by you in the bank shall be conclusive and binding. The bank shall not be released of its obligations under these presents by any exercise by you of its liberty with reference to matter aforesaid or any of their or by reason or any other act of omission or commission on your part or any other indulgence shown by you or by any other matter or changed what so ever which under law would, but for this provision, have the effect of releasing the bank.
  4. The guarantee herein contained shall not be determined or affected by the liquidation or winding up dissolution or changes of constitution or insolvency of the said supplier/contractor but shall in all respects and for all purposes be binding and operative until payment of all money due to you in respect of such liabilities is paid.
  5. The bank undertakes not to revoke this guarantee during its currency without your previous consent and further agrees that the guarantee shall continue to be enforceable until it is discharged by IGGL in writing. However, if for any reason, the supplier/contractor is unable to complete the supply/work within the period stipulated in the order/contract and in case of extension of the date of delivery/completion resulting extension of defect liability period/guarantee period of the supplier/contractor fails to perform the supply/work fully, the bank hereby agrees to further extend this guarantee at the instance of the supplier/contractor till such time as may be determined by IGGL. If any further extension of this guarantee is required, the same shall be extended to such required period on receiving instruction from M/s \_\_\_\_\_ (contractor) on whose behalf this guarantee is issued.
  6. Bank also agrees that IGGL at its option shall be entitled to enforce this Guarantee against the bank (as principal debtor) in the first instant, without proceeding against the supplier/contractor and notwithstanding any security or other guarantee that IGGL may have in relation to the supplier's/contractor's liabilities.
  7. The amount under the Bank Guarantee is payable forthwith without any delay by Bank upon the written demand raised by IGGL. Any dispute arising out of or in relation to the said Bank Guarantee shall be subject to the exclusive jurisdiction of courts at Guwahati.
  8. Therefore, we hereby affirm that we are guarantors and responsible to you on behalf of the Supplier/Contractor up to a total amount of \_\_\_\_\_ (amount of guarantees in words and figures) and we undertake to pay you, upon your first written demand declaring the Supplier/Contractor to be in default under the order/contract and without caveat or argument, any sum or sums within the limits of (amounts of guarantee) as aforesaid, without your needing to prove or show grounds or reasons for your demand or the sum specified therein.
  9. We have power to issue this guarantee in your favor under Memorandum and Articles of Association and the undersigned has full power to do under the Power of Attorney, dated \_\_\_\_\_ granted to him by the Bank.



=====

10. Notwithstanding anything contained herein:

- a) The Bank’s liability under this Guarantee shall not exceed (currency in figures) ..... (currency in words only) .....
- b) This Guarantee shall remain in force upto \_\_\_\_\_(this date should be 3 months beyond the expiry date of defect liability period/Guarantee/Warranty of the contract) and any extension(s) thereof; and
- c) The Bank shall be released and discharged from all liability under this Guarantee unless a written claim or demand is issued to the Bank on or before the midnight of .....(indicate date of expiry of claim period which includes minimum three months from the expiry of this Bank Guarantee) and if extended, the date of expiry of the last extension of this Guarantee. If a claim has been received by us within the said date, all the rights of IGGL under this Guarantee shall be valid and shall not cease until we have satisfied that claim.

Details of next Higher Authority of the Officials who have issued the Bank Guarantee:

Name .....

Designation .....

Yours faithfully,

\_\_\_\_\_

Bank by its Constituted Attorney  
Signature of a person  
duly Authorized to sign on behalf of  
the Bank

INSTRUCTIONS FOR FURNISHING

"CONTRACT PERFORMANCE SECURITY / SECURITY DEPOSIT" BY "BANK GUARANTEE"

- 1. The Bank Guarantee by successful Bidder(s) will be given on non-judicial stamp paper as per 'stamp duty' applicable. The non-judicial stamp paper should be in name of the issuing bank. In case of foreign bank, the said Bank Guarantee to be issued by its correspondent bank in India on requisite non-judicial stamp paper and place of Bid to be considered as Guwahati.
- 2. The Bank Guarantee by Bidders will be given from bank as specified in Tender.
- 3. A letter from the issuing bank of the requisite Bank Guarantee confirming that said Bank Guarantee and all future communication relating to the Bank Guarantee shall be forwarded to Purchaser.
- 4. If a Bank Guarantee is issued by a commercial bank, then a letter to Purchaser and copy to Consultant (if applicable) confirming its net worth is more than Rs. 100,00,00,000.00 [Rupees One Hundred Crores] or its equivalent in foreign currency along with Documentary evidence OR in the Bank Guarantee itself.

**5. THE BANK GUARANTEE ISSUED BY THE BANK MUST BE ROUTED THROUGH SFMS PLATFORM AS PER FOLLOWING DETAILS:**

"BG issuance message (IFN 760 / IFN760COV For issuance of BG and IFN 767 / IFN 767 COV FOR Amendment of BG) is to be transmitted through SFMS to beneficiary’s bank as below:

=====

Name of Bank : Axis Bank  
 Branch : Guwahati  
 Branch Address : Chhibber House, Ground Floor, G.S Road, Guwahati -781005  
 IFSC : UTIB0000140  
 SWIFT Code : AXISINBB140

The issuing bank while issuing/amending the BG, should ensure that the below information is correctly captured in the message i.e., IFN 760 / IFN 760COV / IFN 767/ IFN 767COV:

Field Number	Particulars
7037	IGGL938956645

NOTE: THE BANK GUARANTEE ISSUED BY THE BANK MUST BE ROUTED THROUGH SFMS PLATFORM AS PER FOLLOWING DETAILS:

- (i) IFN 760 / IFN 760COV FOR ISSUANCE OF BANK GUARANTEE
- (ii) IFN 767 / IFN 767 COV FOR AMENDMENT OF BANK GUARANTEE
- (iii) THE ABOVE MESSAGE / INTIMATION SHALL BE SENT THROUGH SFMS BY THE BG ISSUING BANK TO AXIS BANK, GUWAHATI BRANCH, IFSC CODE – UTIB0000140; BRANCH ADDRESS: Axis Bank, Chhibber House, Ground Floor, G.S Road, Guwahati -781005
- (iv) THE SUPPLIER SHALL SUBMIT TO IGGL THE COPY OF SFMS MESSAGE AS SENT BY THE ISSUING BANK ALONG WITH THE ORIGINAL BANK GUARANTEE

XX

**MATTER TO BE MENTIONED IN COVERING LETTER TO BE SUBMITTED BY VENDOR ALONG WITH BANK GUARANTEE**

1	<b>BANK GUARANTEE NO</b>	:				
2	<b>VENDOR NAME / VENDOR CODE</b>	:	<b>NAME</b>			
			<b>VENDOR CODE</b>			
3	<b>BANK GUARANTEE AMOUNT</b>	:				
4	<b>PURCHASE ORDER/ LOA NO</b>	:				
5	<b>NATURE OF BANK GUARANTEE</b>	:				
	<b>(Please Tic (√) Whichever is Applicable</b>		<b>PERFORMANCE BANK GUARANTEE</b>	<b>SECURITY DEPOSIT</b>	<b>EMD</b>	<b>ADVANCE</b>
6	<b>BG ISSUED BANK DETAILS</b>	(A)	<b>EMAIL ID:</b>			
(B)		<b>ADDRESS:</b>				
(C)		<b>PHONE NO:</b>				

=====

**F-5**  
**AGREED TERMS & CONDITIONS**

To,

M/s IGGL

\_\_\_\_\_

**TENDER NO:** IGGL/GHY/C&P/PROJ/BALL-VALVE/04-26

This Format duly filled in, signed & stamped must form part of Bidder's Bid and must be submitted in Part-I (Un-priced Bid). Clauses confirmed hereunder need not be repeated in the Bid.

SL. NO.	DESCRIPTION	BIDDER'S CONFIRMATION
1.	Bidder's name and address (FOA/Order shall be released in this name)	Bidder's name: Address:
2.	Bidder furnishes bid security declaration OR EMD/Bid Security details as under a) EMD/Bid Security No. & date b) Value c) Validity d) Bank Address/e-mail ID/Mobile no. (in case of BG) <b>OR</b> Bidder furnishes bid security declaration [applicable for bidders to whom exemption is allowed as per cl. no. 16.9 of Section-III]	
3.	Bidder confirms the currency of quoted prices is in Indian Rupees.	
4.	Bidder Confirms quoted prices will remain firm and fixed till complete execution of the order (except where price escalation/variation is allowed in the Tender).	
5.	Bidder confirms that quoted prices are strictly as per Price Schedule format of the Tender document.	
6.	Bidder specify the Dispatch Point [Location, Dist. & State from where material will be dispatched]:	
7.	Bidder confirms acceptance of relevant Terms of Payment specified in the Bid Document.	
8.	Bidder confirms that Contract Performance Security / Security Deposit (CPS) will be furnished as per Bid Document within 30 days of FOA in case of successful bidder.	

SL. NO.	DESCRIPTION	BIDDER'S CONFIRMATION
9.	Bidder confirms that CPS shall be from any Indian scheduled bank (excluding Co-operative banks and Regional Rural bank) or a branch of an International bank situated in India and registered with Reserve bank of India as scheduled foreign bank. However, in case of bank guarantees from banks other than the Nationalised Indian banks, the bank must be a commercial bank having net worth in excess of Rs 100 crores and a declaration to this effect shall be made by such commercial bank either in the Bank Guarantee itself or separately on its letterhead.	
10.	Bidder confirms acceptance to Delivery/Completion Period as per Bid document.	
11.	(i) Bidder confirms acceptance of Price Reduction Schedule (PRS) for delay in delivery as specified in Bid document. (ii) In case of delay, the bills shall be submitted after reducing the price reduction due to delay (refer PRS clause)	
12.	a) Bidder confirms acceptance of all terms and conditions of Bid Document (all sections & enclosures) including GCC, Pre-bid minutes and corrigendum (If any) b) Bidder confirms that printed terms and conditions of bidder are not applicable.	
13.	Bidder confirms that their offer is valid for period specified in BDS from the final 'Bid Due Date'.	
14.	Bidder confirms that (i) none of Directors (in Board of Director) of bidder is a relative of any Director (in Board of Director) of IGGL <b>or</b> (ii) the bidder is not a firm in which any Director (in Board of Director) of IGGL or their relative is a partner.	
15.	Bidder confirms that all correspondence must be in ENGLISH language only.	
16.	Bidder confirms that all Bank charges associated with Bidder's Bank regarding release of payment etc. shall be borne by Bidder.	
17.	Bidder confirms that the quoted prices is in compliance with the Section 171 of CGST Act/ SGST Act as mentioned as clause no. 13.10 of ITB (Anti-profiteering clause)	
18.	Bidder to confirm the GST % (CGST & SGST/UTGST or IGST) applicable for the SOR items.	
19.	Bidder confirms that their GST registration is valid	

SL. NO.	DESCRIPTION	BIDDER'S CONFIRMATION
20.	Whether in the instant tender items are covered in reverse charge rule of GST (CGST & SGST/UTGST or IGST).	Yes / No
21.	Bidder confirms that they have mentioned Harmonized System Nomenclature (HSN) in Bid.	
22.	Bidder confirms that (i) any variation in GST at the time of supplies for any reasons, other than statutory, including variations due to turnover, shall be borne by them and (ii) any error of interpretation of applicability of rate of GST (CGST & SGST/ UTGST or IGST) on components of an item and/or various items of tender by them shall be to bidder's account.	
23.	Whether bidder is liable to raise E-Invoice as per GST Act.	Yes / No
	If yes, bidder will raise E-Invoice and confirm compliance to provision of tender in this regard.	
24.	<b>Part Order:</b> (a) Bidder confirms acceptance to Part Order.	
	(b) Bidder confirms that any charges quoted extra as lumpsum shall be applicable prorata on value basis in the event of part order.	
25.	As per requirement of tender, bidder (having status as Pvt. Ltd. Or Limited company) must upload bid duly digitally signed on eportal through class-3B digital signature (DS). In case, class of DS or name of employee or name of employer is not visible in the digitally signed documents, the bid digitally signed as submitted by the person shall be binding on the bidder.	
26.	<b>No Deviation Confirmation:</b> It may be noted that any 'deviation / exception' in any form may result in rejection of Bid. Therefore, Bidder confirms that they have not taken any 'exception / deviation' anywhere in the Bid. In case any 'deviation / exception' is mentioned or noticed, Bidder's Bid may be rejected.	

SL. NO.	DESCRIPTION	BIDDER'S CONFIRMATION
27.	<p><b><u>Non-Involvement of Govt. of India:</u></b>                      If Bidder becomes a successful Bidder and pursuant to the provisions of the Tender Document, the following Confirmation shall be automatically enforceable:                      "Bidder agrees and acknowledges that the Employer is entering into the Contract/Agreement solely on its own behalf and not on behalf of any other person or entity. In particular, it is expressly understood &amp; agreed that the Government of India is not a party to the Contract/Agreement and has no liabilities, obligations or rights thereunder. It is expressly understood and agreed that the Purchaser is authorized to enter into Contract/Agreement, solely on its own behalf under the applicable laws of India. Bidder expressly agrees, acknowledges and understands that the Purchaser is not an agent, representative or delegate of the Government of India. It is further understood and agreed that the Government of India is not and shall not be liable for any acts, omissions, commissions, breaches or other wrongs arising out of the Agreement. Accordingly, Bidder hereby expressly waive, release and forego any and all actions or claims, including cross claims, VIP claims or counter claims against the Government of India arising out of the Agreement and covenants not to sue to Government of India as to any manner, claim, cause of action or things whatsoever arising of or under the Agreement."</p>	
28.	<p><b><u>Holiday/Banning</u></b>                      Bidder hereby confirms that they are not on Holiday by IGGL or Public Sector Project Management Consultant (like EIL, MECON only due to "poor performance" or "corrupt and fraudulent practices") or banned by Government Department / Public Sector on due date of submission of bid.                      Further, Bidder confirms that neither they nor their allied agency/(ies) (as defined in the Procedure for Action in case of Corrupt/ Fraudulent/ Collusive/ Coercive Practices) are on banning list of IGGL or the Ministry of Petroleum and Natural Gas.                      Further, Bidder also confirms that in case there is any change in status of the declaration prior to award of contract, the same will be promptly informed to IGGL by them.</p>	

SL. NO.	DESCRIPTION	BIDDER'S CONFIRMATION
29.	The contents of this Tender Document have not been modified or altered by Bidder. In case, it is found that the tender document has been modified / altered by the bidder, the bid submitted by them shall be liable for rejection.	
30.	Bidder confirms that they have read and understood the General Conditions of Contract enclosed at Section-IV & no 'exception / deviation' anywhere has been taken in the same and that they shall abide by provisions of relevant GCC.	
31.	Bidder certifies that they would adhere to the Fraud Prevention Policy of IGGL [available on IGGL's website (www.iggl.co.in)] and shall not indulge themselves or allow others (working in IGGL) to indulge in fraudulent activities and that they would immediately apprise IGGL of the fraud/suspected fraud as soon as it comes to their notice. Concealment of facts regarding their involvement in fraudulent activities in connection with the business transaction(s) of IGGL is liable to be treated as crime and dealt with by the procedures of IGGL as applicable from time to time.	
32.	Bidders confirm to submit signed copy of Integrity Pact (wherever included in tender). If Bidder is a partnership concern or a consortium, this agreement must be signed by all partners or consortium members.	
33.	Bidder confirms that there is no conflict of interest with other bidders, as per clause no. 4.2 of Section-III (ITB) of Tender Document.	
34.	Confirm that, in case of contradiction between the confirmations provided in this format and terms & conditions mentioned elsewhere in the offer, the confirmations given in this format shall prevail.	

Place:  
Date:

[Signature of Authorized Signatory of Bidder]  
Name:  
Designation:  
Seal:

=====

**F-6**

**ACKNOWLEDGEMENT CUM CONSENT LETTER**

**(On receipt of tender document/information regarding the tender, Bidder shall acknowledge the receipt and confirm his intention to bid or reason for non-participation against the enquiry /tender through e-mail/fax to concerned executive in IGGL who issued the tender document, by filling up the Format)**

To,

M/s IGGL

\_\_\_\_\_

**TENDER NO:** IGGL/GHY/C&P/PROJ/BALL-VALVE/04-26

Dear Sir,

We hereby acknowledge receipt of a complete set of Tender Document along with enclosures for subject item/job and/or the information regarding the subject tender.

- We intend to bid as requested for the subject item/job and furnish following details with respect to our quoting office:

Postal Address with PIN Code: .....

Telephone Number: .....

Fax Number: .....

Contact Person: .....

E-mail Address: .....

Mobile Number: .....

Date: .....

Seal/Stamp: .....

- We are unable to bid for the reason given below:

Reason for non-submission of bid:

\_\_\_\_\_

Agency's Name: .....

Signature: .....

Name: .....

Designation: .....

Date: .....

Seal/Stamp: .....

=====

**F-7**

**BIDDER'S EXPERIENCE**

To,  
M/s IGGL

**TENDER NO:** IGGL/GHY/C&P/PROJ/BALL-VALVE/04-26

Sl. No.	Description of the Supply / Services	PO / Contract No. and date	Full Address & phone nos. of Client.	Postal & nos. of	Value of Contract /Order (Specify Currency Amount)	Date of Commencement	Scheduled Completion / Delivery Period (Months)	Date of Actual Completion	Reasons for delay in execution, if any
(1)	(2)	(3)	(5)	(6)	(7)	(8)	(9)	(10)	

Place:  
Date:

[Signature of Authorized Signatory of Bidder]  
Name:  
Designation:  
Seal:

**Note:**

**Only documents (Purchase Order / Work Order, Completion certificate, Execution Certificate etc.) which have been referred/ specified in the bid shall be considered in reply to queries during evaluation of Bids.**

=====

**F-8**  
**CHECK LIST**

Bidders are requested to duly fill in the checklist. This checklist gives only certain important items to facilitate the bidder to make sure that the necessary data/information as called for in the Tender document has been submitted by them along with their offer/bid. This, however, does not relieve the bidder of his responsibilities to make sure that his offer is otherwise complete in all respects. Please ensure compliance and tick (√) against following points:

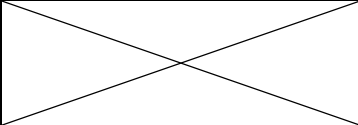
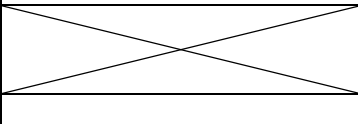
S. No.	DESCRIPTION	CHECK BOX	REFERENCE PAGE NO. OF THE BID SUBMITTED
1.0	Confirm that the following details have been submitted in the Un-priced part of the bid		
i	Covering Letter, Letter of Submission		
ii	EMD/Bid Security/Declaration for Bid Security [as applicable] as per provisions of Tender		
iii	Digitally Signed Tender document along with drawings and corrigendum (if any)		
iv	Power of Attorney in the name of person signing the bid.		
v	Confirm submission of document along with unpriced bid as per tender requirement (including cl. no. 11.1.1 of Section-III)		
2.0	Confirm that all forms duly filled in are enclosed with the bid duly signed by authorised person(s).		
3.0	Confirm that the price part is uploaded in CPP portal		
4.0	Confirm that Undertaking as per Form-1 to Section-II have been submitted by the bidder (Guidelines from Procurement from a Country sharing a Land Border with India)		

Place:

Date:

[Signature of Authorized Signatory of Bidder]

Name:

Designation:

Seal:

=====

**F-9**  
**FORMAT FOR CERTIFICATE FROM BANK**  
**IF BIDDER'S WORKING CAPITAL IS INADEQUATE/NEGATIVE**

(To be provided on Bank's letter head)

Date:

To,  
M/s. IGGL  
-----  
-----  
-----

Dear Sir,

This is to certify that M/s ..... (name of the bidder with address) (hereinafter referred to as Customer) is an existing customer of our Bank.

The Customer has informed that they wish to bid for IGGL's Tender no. .... dated ..... for .....(Name of the supply/work/services/consultancy) and as per the terms of the said Tender document they have to furnish a certificate from their Bank confirming the availability of line of credit.

Accordingly, M/s ..... (name of the Bank with address) confirms availability of line of credit to M/s ..... (name of the bidder) for at least an amount of Rs. \_\_\_\_\_

It is also confirmed that the net worth of the Bank is more than Rs. 100 Crores (or Equivalent USD) and the undersigned is authorized to issue this certificate.

Yours truly

for ..... (Name & address of Bank)

(Authorized signatory)

Name of the signatory :

Designation :

Email Id :

Contact No. :

Stamp

**Note:**

This Declaration Letter for line of credit shall be from single bank only. Letter from multiple banks shall not be applicable. However, banking syndicate will be acceptable wherein a group of banks can jointly provide line of credit to the bidder.

**F-10**

**FORMAT FOR CHARTERED ACCOUNTANT CERTIFICATE/ CERTIFIED PUBLIC ACCOUNTANT (CPA)  
FOR FINANCIAL CAPABILITY OF THE BIDDER**

We have verified the Audited Financial Statements and other relevant records of M/s..... (Name of the bidder) and certify the following:

**A. AVERAGE ANNUAL FINANCIAL TURNOVER\* DURING THE LAST THREE FINANCIAL YEARS:**

Year	Amount (Currency)
Year 1:	
Year 2:	
Year 3:	
Total (A)	
Average Annual Financial Turnover during the last three financial years (A/3)	

**B. NETWORTH\* AS PER LAST AUDITED FINANCIAL STATEMENT:**

Description	Year _____
	Amount (Currency)
1. Net Worth:	

**C. WORKING CAPITAL\* AS PER LAST AUDITED FINANCIAL STATEMENT:**

Description	Year _____
	Amount (Currency)
1. Current Assets	
2. Current Liabilities	
3. Working Capital (Current Assets-Current liabilities)	

***\*Refer Instructions***

**Note:**

- 1.0 It is further certified that the above-mentioned applicable figures are matching with the returns filed with Registrar of Companies (ROC) [Applicable only in case of Indian Companies].
- 2.0 We confirm that above figures are after referring instructions at page 2 of 2 of F-10.
- 3.0 Practicing Chartered Accountants shall generate Unique Document Identification Number (UDIN) for all certificates issued by them

Name of Audit Firm:

[Signature of Authorized Signatory]

Chartered Accountant/CPA

Name:

Date:

Designation:

Seal:

Membership No.

=====

## **INSTRUCTIONS:**

1. The Separate Pro-forma shall be used for each member in case of JV/Consortium.
2. The financial year would be the same as one normally followed by the bidder for its Annual Report.
3. The bidder shall provide the audited annual financial statements as required for this Tender document. Failure to do so would result in the Proposal being considered as non-responsive.
4. For the purpose of this Tender document:
  - a. **Annual Turnover** shall be "Revenue from operation" as per profit & Loss account of audited annual financial statements.
  - b. **Working Capital** shall be "Current Assets less Current liabilities" and
  - c. **Net Worth** shall be aggregate value of the paid-up share capital and all reserves created out of the profits and securities premium account, after deducting the aggregate value of the accumulated losses, deferred expenditure and miscellaneous expenditure not written off, if any, but does not include reserves created out of revaluation of assets, writeback of depreciation and amalgamation.
5. In case the date of constitution/incorporation of the bidder is less than 3 years old, the average turnover in respect of the completed financial years after the date of constitution/ incorporation shall be taken into account for minimum Average Annual Financial Turnover criteria.
6. **Above figures shall be calculated after considering the qualification, if any, made by the statutory auditor on the audited financial statements of the bidder including quantified financial implication.**
7. This certificate is to be submitted on the letter head of Chartered Accountant/CPA.

=====

**F-11**

**BIDDER'S QUERIES FOR PRE-BID MEETING**

**To,**

**M/s. IGGL**

**TENDER NO: IGGL/GHY/C&P/PROJ/BALL-VALVE/04-26**

SL. NO.	REFERENCE OF TENDER DOCUMENT				BIDDER'S QUERY	IGGL'S REPLY
	SEC. NO.	Page No.	Clause No.	Subject		

**NOTE: The Pre-Bid Queries may be sent by e-mail before due date for receipt of Bidder's queries.**

**SIGNATURE OF AUTHORISED REPRESENTATIVE OF BIDDER: \_\_\_\_\_**

**NAME OF BIDDER : \_\_\_\_\_**

-----  
**F-12**

**E-Banking Mandate Form**

(To be issued on vendor's letter head)

1. Vendor/customer Name :
2. Vendor/customer Code :
3. Vendor /customer Address :
4. Vendor/customer e-mail id :
  
5. Particulars of bank account
  - a) Name of Bank
  - b) Name of branch
  - c) Branch code:
  - d) Address:
  - e) Telephone number:
  - f) Type of account (current/saving etc.)
  - g) Account Number:
  - h) RTGS IFSC code of the bank branch
  - i) NEFT IFSC code of the bank branch
  - j) 9-digit MICR code

I/We hereby authorize IGGL to release any amount due to me/us in the bank account as mentioned above. I/We hereby declare that the particulars given above are correct and complete. If the transaction is delayed or lost because of incomplete or incorrect information, we would not hold the IGGL responsible.

(Signature of vendor/customer)

**BANK CERTIFICATE**

We certify that ----- has an Account no. ----- with us and we confirm that the details given above are correct as per our records.

Bank stamp

Date

(Signature of authorized officer of bank)

**F-13**

**FREQUENTLY ASKED QUESTIONS (FAQs)**

<b>SL.NO.</b>	<b>QUESTION</b>	<b>ANSWER</b>
1.0	Can any vendor quote for subject Tender?	Yes. A Vendor has to meet Bid Evaluation Criteria given under Section II of Tender document in addition to other requirements.
2.0	Should the Bid Evaluation Criteria documents be attested?	Yes (If referred in Section II of Tender document).
3.0	Is attending Pre-Bid Meeting mandatory.	No. Refer Clause No. 17 of Instruction to Bidders of Tender Document. However, attending Pre-Bid Meeting is recommended to sort out any issue before submission of bid by a Bidder.
4.0	Can a vendor submit more than 1 offer?	No. Please refer Clause No. 4 of Instruction to Bidders of Tender Document.
5.0	Is there any Help document available for e-tender	Yes. Refer Annexure III to Instructions to Bidders of Tender Document and FAQs as available on Govt. e-Procurement System of National Informatics Center (NIC)
6.0	Are there are any MSE (Micro & Small Enterprises) benefits available?	Yes. Refer Clause No. 40 of Instructions to Bidders of Tender Document.
7.0	Are there any benefits available to Start-ups?	Refer Clause No. 48 of Instructions to Bidders of the Tender Document and BDS

All the terms and conditions of Tender remain unaltered.

**F-14**

**UNDERTAKING REGARDING SUBMISSION OF ELECTRONIC INVOICE (E-INVOICE AS PER GST LAWS)**

**(To be submitted on letter head along with documents for release of payment)**

To,  
M/s IGGL  
.....

**SUB:** PROCUREMENT OF BALL VALVE FOR BI- DIRECTIONAL FLOW ARRANGEMENT IN COMPRESSOR STATION, BAIHATA

PO NO: .....

**Dear Sir,**

We \_\_\_\_\_ (Name of the Supplier) hereby confirm that E-Invoice provision as per the GST Law is

- (i) Applicable to us [       ]
- (ii) Not Applicable to us [       ]

**(Supplier is to tick appropriate option (✓) above).**

In case, same is applicable to us, we confirm that we will submit E-Invoice after complying with all the requirements of GST Laws. If the invoice issued without following this process, such invoice can-not be processed for payment by IGGL as no ITC is allowed on such invoices. We also confirm that If input tax credit is not available to IGGL for any reason attributable to Supplier (both for E-invoicing cases and non-E-invoicing cases), then IGGL shall not be obligated or liable to pay or reimburse GST (CGST & SGST/UTGST or IGST) claimed in the invoice(s) and shall be entitled to deduct / setoff / recover such GST amount (CGST & SGST/UTGST or IGST) or Input Tax Credit amount together with penalties and interest, if any, by adjusting against any amounts paid or becomes payable in future to the Supplier under this contract or under any other contract.

Place: [Signature of Authorized Signatory of Bidder]  
 Date: Name:  
 Designation:  
 Seal:

**F-15**

**DECLARATION ON PROCEEDINGS UNDER INSOLVENCY AND BANKRUPTCY  
CODE 2016**

To,  
M/s IGGL  
.....

**SUB:** PROCUREMENT OF BALL VALVE FOR BI- DIRECTIONAL FLOW ARRANGEMENT IN COMPRESSOR STATION, BAIHATA

**Tender No.:** IGGL/GHY/C&P/PROJ/BALL-VALVE/04-26

Dear Sir,

I/ We hereby declare that I/We, M/s \_\_\_\_\_, declare that:

(i) I/We am/are not undergoing insolvency resolution process or liquidation or bankruptcy proceeding as on date

**OR**

(ii) I/We am/are undergoing insolvency resolution process or liquidation or bankruptcy proceeding as on date as per details mentioned below

- (a) \_\_\_\_\_
- (b) \_\_\_\_\_
- (c) \_\_\_\_\_

(Attach details in separate sheet)

(iii) Further, I / We also confirms that in case there is any change in status of this declaration at any stage of tendering / execution (in case of award), the same will be promptly informed to IGGL.

**Note: Strike out either (i) or (ii) as applicable.**

It is understood that if this declaration is found to be false, Indradhanush Gas Grid Limited shall have the right to reject my/our bid, and forfeit the EMD/CPS. If the bid has resulted in a contract, the contract will be liable for termination without prejudice to any other right or remedy (including black listing or holiday listing) available to Indradhanush Gas Grid Limited.

Place:	[Signature of Authorized Signatory of Bidder]
Date:	Name:
	Designation:
	Seal:

F-16

**NO CLAIM CERTIFICATE**  
**(TO BE SUBMITTED BEFORE RELEASE OF CPS/SECURITY DEPOSIT)**

***[On the Letter-head of Contractor]***

We, \_\_\_\_\_, a company incorporated under the laws of India/ a Consortium between \*\_\_ and \*\_\_ (*name of Consortium partners to be inserted*)/ a Partnership Firm consisting of \*\_\_ and \*\_\_ (*name of Partners to be inserted*)/ a Sole Proprietorship (as the case may be), having its registered office at \_\_\_\_\_ and carrying on business under the name and style M/s. \_\_\_\_\_ were awarded the contract by IGGL in reference to Tender No. \_\_\_\_\_ dated \_\_\_\_\_ ("Order/Contract").

After completion of the above-said items/job under the Order/Contract, we have scrutinized all our claims, contentions, disputes, issues and we hereby confirm that after adjusting all payments received by us against our R.A. Bills and final bill, we have no claims, dues, issues and contentions from IGGL

We further absolve IGGL from all liabilities present or future arising directly or indirectly out of the Contract.

There is no economic duress or any other compulsion on us for submission of this no claim certificate.

Place: [Signature of Authorized Signatory of Contractor]

Date: Name:

Designation:

Seal:

---

**SECTION-VI**

**SPECIAL CONDITIONS OF CONTRACT**

**&**

**SCOPE OF WORK**

## **SPECIAL CONDITIONS OF CONTRACT (SALIENT FEATURES)**

### **1) INTRODUCTION:**

Indradhanush Gas Grid Limited (IGGL) is executing the North East Natural Gas Grid (NEGG) Pipeline Project in the states of Assam, Arunachal Pradesh, Nagaland, Manipur, Mizoram, Meghalaya, Tripura, West Bengal & Sikkim.

The NEGG project is being executed in three phases. The Guwahati-Numaligarh Pipeline Section, under NEGG phase-I, has been commissioned and has entered the O&M phase.

### **2) SCOPE OF SUPPLY:**

The Scope of supply includes the following Ball Valve conforming to Size, Rating and other details as mentioned below in Table-A and meeting other technical requirements as specified in bid document, getting approvals from Purchaser, procurement of raw material, manufacturing, testing & inspection, packing, forwarding & transportation, delivery, unloading and stacking at owner's store in the state of Assam / Meghalaya as per tender terms & conditions. The details of Ball Valve to be supplied are provided as shown,

**TABLE-A**

Sl. No.	Description	Quantity (Nos.)	Remarks
1	18", 600#, Reduced Bore, Raised Face (Flanged)	4	HOV

The materials are to be delivered to any location in Assam / Meghalaya or in both. The exact delivery location and GST details shall be shared with the Dispatch Clearance. The materials are to be inspected by the TPI agency engaged by the bidder, and the Dispatch Clearance shall be provided by IGGL on submission of the TPI certificate and all necessary documents. TPI to be engaged by the Bidder.

**The bidders should quote the price of materials inclusive of the cost of all materials, packing & forwarding, loading, freight, transit insurance, TPI fees, etc. GST shall be quoted extra.**

The drawings/documents shall be reviewed, checked, approved and duly signed/stamped by successful Bidder/supplier before submission. Revision number shall be changed during submission of the revised successful Bidder/supplier documents and all revisions shall be highlighted by clouds. Whenever the successful Bidder/supplier require any sub-supplier drawings to be reviewed by purchaser, the same shall be submitted by the supplier after duly reviewed, approved and stamped by the successful Bidder/supplier. Direct submission of the sub-supplier's drawings without contractor's approval shall not be entertained.

Review/Approval of the successful Bidder/supplier drawings by purchaser would be only to review the compatibility with basic designs and concepts and in no way absolve the successful Bidder/supplier of his responsibility/contractual obligation to comply with tender requirements, applicable codes, specifications and statutory rules/regulations. Any error / deficiency noticed during any stage of manufacturing / execution / installation shall be promptly corrected by the

successful Bidder/supplier without any extra cost or time, whether comments on the same were received from purchaser during the drawing review stage.

3) **EVALUATION METHODOLOGY:** Applicable as per Section-II of the tender document.

4) **DELIVERY PERIOD:**

The contractual delivery date for all items shall be 32 (Thirty-Two) weeks from the date of FOA.

5) **PRS**

***"Clause 26.0 of GCC shall stand modified to the following extent:***

*In a supply contract, the portion of the supply completed in all respects that can be used for commercial operation shall not be considered for applying PRS if delivered within the contractual delivery period.*

***The value referred to in the PRS clause excludes taxes and duties.***

"As mentioned in GCC, in case delay in supply/ execution of contract, supplier/ contractor/ service provider will raise invoice for reduced value as per the Price Reduction Clause. If the supplier/ contractor/ service provider has raised the invoice for full value, then supplier/ contractor/ service provider will issue a Credit Note towards the applicable PRS amount.

*In case supplier/ contractor/ service provider fails to submit the invoice for reduced value or does not issue credit note as mentioned above, IGGL will release the payment to supplier/ contractor/ service provider after effecting the PRS clause. In the event of any financial implication arises on IGGL due to issuance of invoice without reduction in price or non-issuance of Credit Note, the same shall be to the account of supplier/ contractor/ service provider.*

6) **PAYEMENT TERMS FOR SUPPLY**

**The following shall be read in conjunction with Article 21 of GCC (Goods)**

90% of Invoice value with 100% taxes and duties will be paid progressively on receipt of material at storage yard after adjustment against PRS and against submission of invoice in triplicate along with:

i) Inspection release note by TPI.

ii) Copy of LR

iii) Packing List

iv) Proof of customs clearance including payment of customs duty for imports permitted in the Contract or Declaration of no import content in case there is no import.

v) Dispatch instructions/ clearance by Purchaser/ Purchaser's agency.

The invoice as per GST Act/ Law shall be raised in the name of Officer-in-Charge, Indradhanush Gas Grid Limited, as per the PO.

Balance 10% amount of Invoice value shall be paid within 30 days on receipt and acceptance of complete materials at the storage yard against submission of Claim Advice/ Supplementary Invoice along with: Confirmation by Purchaser/ Purchaser's agency against receipt and acceptance of all documents.

7) **GUARANTEE / WARRANTY:**

Twelve (12) months from the date of use of valve in pipeline (or) 24 months from the date of last shipment whichever period shall expire first

---

## **TECHNICAL SPECIFICATIONS FOR VALVES**

### **1. SCOPE:**

This specification covers the minimum requirements for design, manufacture, testing and supply of carbon steel ball valves of size DN 50 mm (2") and above and ANSI pressure rating class 150 to 900 to be used in on-shore pipeline systems handling non-sour hydrocarbons in liquid or gaseous phase, including Liquefied Petroleum Gas (LPG). This specification does not cover ball valves for sour hydrocarbon (liquid / gas) service as defined in NACE standard MR-01-75.

### **2. REFERENCE DOCUMENTS:**

2.1 Reference has been made in this specification to the latest edition (edition enforce at the time of issue of enquiry) of the following Codes, Standards and Specifications:

ASME B 16.5 : Pipe flanges and flanged fittings

ASME B 16.10 : Face-to-face and end-to-end dimensions of valves

ASME B 16.25 : Butt welding ends

ASME B 16.34 : Valves – flanged, threaded and welding ends

ASME B16.47 : Large diameter steel flanges

ASME B 31.3 : Process piping

ASME B 31.4 : Pipeline transportation systems for liquid hydrocarbons and other liquids

ASME B 31.8 : Gas transmission and distribution piping systems

ASME Sec VIII : Boiler and pressure vessel code - Rules for construction of pressure vessels

ASME Sec IX : Boiler and pressure vessel code - Welding and brazing qualifications

ASTM A 370 : Standard test methods and definitions for mechanical testing of steel products

ASTM B 733 : Autocatalytic nickel phosphorous coating on metals

API 6FA : Fire test for valves

API 607 : Fire test for soft-seated quarter-turn valves

API 1104 : Welding of pipelines and related facilities

BS EN ISO 10497 : Testing of valves – Fire type-testing requirements

MSS-SP-6 : Standard finishes for contact faces of pipe flanges and connecting-end flanges of valves and fittings

MSS-SP-44 : Steel pipeline flanges

SSPC-VIS-1 : Steel structures painting council-visual standard

### **3.0 MATERIALS**

3.1 Material for major components of the valves shall be as indicated in Valve Data Sheet. Other components shall be as per Manufacturer's standard (suitable for the service conditions indicated in Data Sheet) and shall be subject to approval by Purchaser. In addition, the material shall also meet the requirements specified hereinafter.

3.2 Carbon steel used for the manufacture of valves shall be fully killed.

- 3.3 The Carbon Equivalent (CE) of valve end connections which are subject to further field welding by Purchaser, shall not exceed 0.43% (as calculated by the following formula) on check analysis for each heat of steel used:

$$CE = \%C + \frac{\%Mn}{6} + \frac{\%Cr + \%Mo + \%V}{5} + \frac{\%Ni + \%Cu}{15}$$

- 3.4 For Valves specified to be used for Gas service or LPG service, Charpy V-notch test, on each heat of base material shall be conducted as per API 6D Clause 8.5, for all pressure containing parts such as body, end flanges and welding ends as well as bolting material for pressure containing parts. Unless stated otherwise, the Charpy V-notch test shall be conducted at 0 °C. Test procedure shall conform to ASTM A370. The average absorbed energy value of three full sized specimens shall be 27 J. The

minimum impact energy value for any one specimen of the three specimens analysed as above, shall not be less than 22 J.

When Low Temperature Carbon Steel (LTCS) materials are specified in Valve Data Sheet or offered by Manufacturer, the Charpy V-notch test requirements of applicable material standard shall be complied with.

- 3.5 For all such valves where carbon steel is used as ball material, the ball shall have 75 micrometer (0.003 inch) thick Electroless Nickel Plating (ENP) as per ASTM B733 with following classification : SC2, Type II, Class 2. The hardness of plating shall be minimum 50 RC.
- 3.6 For valves specified to be used for Gas service or LPG service, hardness test shall be carried out as per ASTM A370 for each method of manufacture and each heat of steel used in the manufacture of valves. A full thickness cross-section shall be taken for this purpose and the maximum hardness of the materials of valve components shall not exceed 248 HV<sub>10</sub>.
- 3.7 All process-wetted parts, metallic and non-metallic, shall be suitable for the fluids and service specified by the Purchaser. The service gas composition shall be as given elsewhere in the Material Requisition. In addition, Manufacturer shall confirm that all wetted parts are suitable for treated water / seawater environment, which may be used during field testing.
- 3.8 Non-metallic parts of the valves (including O-rings, soft seal etc.) intended for hydrocarbon gas service at pressures of PN 100 (600 #) and above shall be resistant to explosive decompression.

**Compliance with Specification:** The Vendor shall be completely responsible for the design, materials, manufacture & fabrication, testing, inspection, preparation for shipment and transport of the above equipment strictly in accordance with the MR and all attachments thereto. Minimum all pressure containing and pressure controlling parts of Valves and Actuators shall be provided with EN 10204-3.2 certificates.

**Vendor's Scope:** Vendor scope of work includes the equipment with all internals and accessories shown on the datasheets, specifications and all unmentioned parts necessary for a satisfactory operation and testing, except those which are indicated to be out of the vendor's supply.

---

## **Inspection:**

Inspection shall be in accordance with EN 10204 3.2 certification shall be issued for each dispatched valve. Vendor shall appoint anyone of the TPIA for inspection purpose. Vendor has to intimate the TPIA name from below listed agencies to IGGL / MECON prior to perform any inspection activity.

- i. Det Norske Veritas (DNV)
- ii. Germanischer Lloyd
- iii. Bureau Veritas
- iv. Moody International
- v. SGS
- vi. Certification Engineer International Ltd (CEIL)
- vii. Technische Ulierwachungs Verein (TUV)
- viii. Velosi
- ix. American Bureau Services (ABS)
- x. AB-Vincotte
- xi. Lloyd Register of Industrial Services
- xii. VCS Quality Services Private Limited
- xiii. Meenar Global

Bidders to note that the valves supplied by them shall be capable to withstand the field hydro test pressure (i.e. 1.5 times of design pressure) for 6 to 24 hours test holding duration under field / site conditions. The valve's ball / plug (BALL VALVES / PLUG VALVES) shall be kept in either partial or full open condition for entire test duration and test medium will be non-corrosive water. The vendor shall be liable for repair/ replacement of valve if found faulty during site hydro test at his risk & cost. All cost for associated activities like packaging, transportation etc. in connection to repair / replacement of valve shall be borne by the bidder. No claim shall be entertained by the Owner / Purchaser in this regard.

**Strip Test:** Vendor need to demonstrate strip test of bolted body valves. For this test one valve of each ordered size and rating shall be selected at random after successful hydro and pneumatic tests by TPI & IGGL inspector. The valve shall be dismantled completely. Alloy steel parts shall be checked for compliance to relevant material code using Positive material identification technique. Selected valve(s) shall then be reassembled after replacing sacrificial parts like gasket & O-rings and complete final inspection as per approved QAP shall be carried out once again to ensure the repeatability of body seals and seats.

## 4.0 DESIGN AND CONSTRUCTION

4.1 Valve design shall meet the requirements of API 6D and other referred codes and shall be suitable for the service conditions indicated in Valve Data Sheet. The ASME Boiler & Pressure Vessel Code, Section VIII, Division 1, may be used to design the valve body. Allowable stress requirements shall comply with the provisions of ASME B31.3. In addition, corrosion allowance indicated in Valve Data Sheet shall be considered in valve design. However, the minimum wall thickness shall not be less than the minimum requirement of ASME B16.34. The Manufacturer shall have a valid license to use API 6D monogram for manufacture of ball valves.

4.2 For above ground valves, valve body design shall be either fully welded or bolted type, as indicated in Valve Data Sheet. Valve body joints with threads are not permitted.

For buried valves, valve body design shall be fully welded type only. Valve body joints with bolts or threads are not permitted.

4.3 Ball shall be of single piece, solid type construction.

4.4 Valves shall be Full Opening (FO) or Reduced Opening (RO) as indicated in Valve Data Sheet. FO valves shall be suitable for the passage of all types of pipeline scraper and inspection pigs on regular basis without causing damage to either the valve component or the pig. The FO valve shall provide an unobstructed profile for pigging operations in either direction. FO valves shall be designed to minimize accumulation of debris in the seat ring region to ensure that valve movement is not impeded.

The opening size of RO valves shall be corresponding to that of a FO valve of smaller nominal diameter as indicated in table below. For sizes of a particular rating not covered in API 6D, the opening sizes of the RO valve shall be as per Manufacturer's standard.

Nominal Valve Size	Nominal Valve Size for Reduced Opening	Nominal Valve Size	Nominal Valve Size for Reduced Opening
DN <sub>mm</sub> (NPS inches)	DN <sub>mm</sub> (NPS inches)	DN <sub>mm</sub> (NPS inches)	DN <sub>mm</sub> (NPS inches)
450 (18)	350 (14)	1050 (42)	900 (36)

4.5 Ball mounting shall be trunnion / pivot type or as indicated in Valve Data Sheet. Ball mounting, either trunnion or floating, unless otherwise specified, shall be as follows.

Sl. No.	ANSI Pressure Rating	Nominal Valve Size (NPS inches)	
		Floating Ball	Trunnion Mounted
1.	150#	≤ 8"	> 8"
2.	300#	≤ 4"	> 4"
3.	600#	Nil	≥ 2"

Valve design shall minimize the possibility of debris ingress into the trunnion as far as practicable.

- 
- 4.6 Valve seats shall have metal to metal contact. O-rings or other seals, if used for drip tight sealing, shall be encased in a suitable groove in such a manner that it can not be removed from seat ring and there is no extrusion during opening or closing operation of valve at maximum differential pressure corresponding to valve class rating. The seat rings shall be so designed as to ensure sealing at low as well as high differential pressures.
- 4.7 Valves shall have double block and bleed feature to facilitate complete flushing, draining and venting of the valve body cavity.
- 4.8 For valves to be used in liquid service, the body cavity over-pressure shall be prevented by self relieving seat rings / assemblies. A pressure relief hole in the ball is not permitted. Self relieving seat rings shall relieve at a body cavity differential pressure not exceeding 50% of the valve class rating pressure.
- 4.9 Valves shall be designed to withstand a sustained internal vacuum of at least 1 (one) milli-bar in both open and closed positions.
- 4.10 FO valves of nominal size DN 200 mm (8") & above and RO valves of nominal size DN 250 mm (10") & above shall have provision for secondary sealant injection under full line pressure for seat and stem seals. All sealant injection connections shall be provided with a needle valve, a grease fitting and non-return valve. Valve design shall have a provision to replace the sealant injection fitting under full line pressure. Location and arrangement of sealant points shall be as per Figure-1.
- 4.11 Valves shall be provided with vent and drain connections. Location and arrangement of vents and drains shall be as per Figure-1. Body vent and drain shall be provided with valves (ball or plug type). Number and size shall be as per Figure-1.
- 4.12 Valve design shall ensure repair of stem seals / packing under full line pressure.
- 4.13 a) Valve ends shall be either flanged or butt welded or one end flanged and one end butt welded as indicated in Valve Data Sheet. Flanges of the flanged end cast/ forged body valves shall be integrally cast / forged with the body of valve. Face-to-face/ end-to-end dimensions shall conform to API 6D. Face-to-face and end-to-end dimensions for valve sizes not specified in API 6D shall be in accordance with ASME B 16.10. Face-to-face and end-to-end dimensions not shown in API 6D or in ASME B 16.10 shall be as per Manufacturer Standard and shall be subject to approval by Purchaser.
- b) Flanged ends shall have flanges as per ASME B16.5 for valve sizes up to DN 600 mm (24 inches) excluding DN 550 mm (22 inches) and as per MSS-SP-44 / ASME B 16.47 series A for valve sizes DN 550 mm (22 inches) & for DN 650 mm (26 inches) and above. Flange face shall be either raised face or ring joint type (RTJ) as indicated in Valve Data Sheet. Flange face finish shall be serrated or smooth as indicated in Valve Data Sheet. Smooth finish when specified shall be 125 to 200 microinches AARH. In case of RTJ flanges, the groove hardness shall be minimum 140 BHN.

- 
- c) Butt weld end preparation shall be as per ASME B16.25. The thickness of the pipe to which the valve has to be welded shall be as indicated in Valve Data Sheet. Valves shall be without transition pups, unless otherwise specified in Valve Data sheet. In case significant difference exists between thickness of welding ends of valve and connecting pipe, the welding ends of valve shall have bevel preparation as per ASME B31.4 or ASME B31.8, as applicable.
- 4.14 Design of weld end valves shall be such that during field welding operations, the soft seals or plastic components of the valve (where ever used) are not liable to be damaged. The Manufacturer shall furnish necessary field welding instructions and post-weld test procedure to demonstrate integrity and leak-tightness of valves after field welding operations.
- 4.15 Valves shall be provided with ball position indicator and stops of rugged construction at the fully open and fully closed positions.
- 4.16 FO valves of nominal size  $\geq$  DN 200 mm (8") and RO valves of nominal size  $\geq$  DN 250 mm (10") shall be equipped with support foot and lifting lugs. Tapped holes and eye bolts shall not be used for lifting lugs. Height of support foot shall be kept a minimum. The location and size of support foot / lifting lugs shall ensure unrestrictive operation of vent / drain valves.
- 4.17 Valve design shall be such as to avoid bimetallic corrosion between carbon steel and high alloy steel components. Suitable insulation shall be provided as required.
- 4.18 Valves shall be of fire resistant design as per API 607/BS EN ISO 10497/API 6FA, as indicated in Valve Data Sheet.
- 4.19 Valves shall be provided with anti-static devices to ensure electrical continuity between stem / ball and valve body.
- 4.20 Valves shall be suitable for either buried or above ground installation as indicated in Valve Data Sheet.
- 4.21 When stem extension requirement is indicated in Valve Data Sheet, the valves shall have the following provisions :
- a) Valves provided with stem extension shall have water proof outer casing. Length of stem extension shall be as indicated in Valve Data Sheet. The length indicated corresponds to the distance between centerline of the valve opening and the top of mounting flange for valve operating device (gear operator / power actuator as applicable).
- b) Vent and drain connections and sealant injection lines shall be terminated adjacent to the valve operator by means of suitable piping anchored to the valve body. Pipe used shall be API 5L Gr. B / ASTM A 106 Gr. B, with Sch. 80. Fittings shall be ASTM A 105 / ASTM 234 Gr. WPB, Socket Welded, ANSI class 6000.

- 
- c) Stem extension and stem housing design shall be such that the complete assembly will form a rigid unit giving a positive drive under all conditions with no possibility of free movement between valve body, stem extension or its operator.
  - d) Outer casing of stem extension shall have 3/8" or 1/2" NPT plugs at the top and bottom, for draining and filling with oil to prevent internal corrosion.

## 4.22 Operating Devices

- a) Valves shall have a power actuator or manual operator as indicated in Valve Data Sheet. In case of manual operator, valve sizes  $\leq$  DN 100 mm (4 inches) shall be wrench operated and valve sizes  $\geq$  DN 150 mm (6 inches) shall be gear operated. Each wrench – operated valve shall be supplied with wrench. Valve design shall be such that damage due to malfunctioning of the operator or its controls will only occur in the operator gear train or power cylinder and that damaged parts can be replaced without the valve cover being removed.
- b) The power actuator shall be in accordance with the Purchaser specification issued for the purpose and as indicated in Valve and Actuator Data Sheet. Operating time shall be as indicated in Valve Data Sheet. Valve operating time shall correspond to full close to full open/full open to full close under maximum differential pressure corresponding to the valve rating. For actuated valves, the actuator torque output shall be 1.25 times the break torque required to operate the ball valve under the maximum differential pressure corresponding to the valve class rating.
- c) For manual operator of all valves, the diameter of the hand wheel or the length of operating wrench shall conform to API 6D requirements and be such that under maximum differential pressure, the total force required to operate the valve does not exceed 350 N. Manufacturer shall also indicate the number of turns of hand wheel (in case of gear operators) required for operating the valve from full open to full close position.
- d) Direction of operation of hand wheel or wrench shall be in clock-wise direction while closing the valve. Hand wheels shall not have protruding spokes.
- e) Gear operators, when provided, shall have a self locking provision and shall be fully encased, in water proof/ splash proof/ dust proof/ weather proof enclosure and shall be filled with suitable grease.
- f) Operating devices shall be designed for easy operation of the valve under maximum differential pressure corresponding to the valve rating.

4.23 All welds shall be made by welders and welding procedures qualified in accordance with the provisions of ASME Section IX. The procedure qualification shall include impact test and hardness test and shall meet the requirements of clauses 3.4 and 3.6 of this specification, respectively.

4.24 All welds shall be stress relieved in accordance with ASME Section VIII.

- 
- 4.25 Repair by welding is not permitted for fabricated and forged body valves. However, repair by welding as per ASME B16.34 is permitted for cast body valves. Such repairs shall be carried out at casting supplier's care only. Repair shall be carried out before any heat treatment of casting is done. Repair welding procedure qualification shall also include impact test and hardness test and shall meet the requirements of clauses 3.4 & 3.6 of this specification, respectively.
- 4.26 The tolerance on internal diameter and out of roundness at the ends for welded end valves shall be as per applicable connected pipe specification as indicated in Valve Data Sheet.
- 4.27 When indicated in Material Requisition, valves shall have locking device to lock the valve either in full open (LO) or full close (LC) positions. Locking devices shall be permanently attached to the valve operator and shall not interfere with operation of the valve.
- 4.28 Valve stem shall be capable of withstanding the maximum operating torque required to operate the valve against the maximum differential pressure corresponding to applicable class rating. The combined stress shall not exceed the maximum allowable stresses specified in ASME Section VIII, Division I. In case of power actuated valves, the valve stem shall be designed for maximum output torque of the selected power actuator (including gear box, if any) at valve stem.

## 5.0 INSPECTION AND TESTS

- 5.1 The Manufacturer shall perform all inspection and tests as per the requirements of this specification and the relevant codes, prior to shipment, at his works. Such inspection and tests shall be, but not limited to, the following:
- 5.1.1 All valves shall be visually inspected. The internal and external surfaces of the valves shall be free from any strikes, gouges and other detrimental defects. The surfaces shall be thoroughly cleaned and free from dirt, rust and scales.
- 5.1.2 Dimensional check on all valves shall be carried out as per the Purchaser approved drawings.
- 5.1.3 Chemical composition and mechanical properties shall be checked as per relevant material standards and this specification, for each heat of steel used.
- 5.1.4 Non-destructive examination of individual valve material and components consisting of, but not limited to castings, forgings, plate and assembly welds shall be carried out by the Manufacturer.
- a) Body castings of all valves shall be radiographically examined on 100% of the surface of critical areas as per ASME B16.34. Procedure and acceptance criteria shall be as per ASME B16.34. The extent of radiography shall be as follows:

ANSI Pressure Rating	Valve Size	Extent of Radiography
150 #	All sizes	Nil
300 #	$\leq$ DN 400mm (16") $\geq$ DN 450mm (18")	Nil 100%
$\geq$ 600 #	All sizes	100%

All castings shall be wet magnetic particle inspected 100% of the internal surfaces. Method and acceptance shall comply with ASME B.16.34.

- b) All valves, with body fabricated from plates or made by forgings, shall be ultrasonically examined in accordance with the procedure and acceptance standard of Annexure E of ASME B16.34.

All forgings shall be wet magnetic particle inspected 100% of the internal surfaces. Method and acceptance shall comply with ASME B 16.34

- c) Bodies and bonnets made by welded assembly of segments of castings, forgings, plates or combinations thereof shall be examined, as applicable, by methods of clause 5.1.4 a) for cast components or clause 5.1.4 b) for forged components and plates.

5.1.5 Full inspection by radiography shall be carried out on all welds of pressure containing parts. Acceptance criteria shall be as per ASME B 31.4 or ASME B31.8, as applicable, and API 1104.

5.1.6 Welds, which in Purchaser's opinion cannot be inspected by radiographic methods, shall be checked by ultrasonic or magnetic particle methods and acceptance criteria shall be as per ASME Section VIII, Division 1, Appendix 12 and Appendix 6, respectively.

5.1.7 a) All finished wrought weld ends subject to welding in field shall be 100% ultrasonically tested for lamination type defects for a distance of 50mm from the end. Laminations shall not be acceptable.

- b) Weld ends of all cast valves subject to welding in field shall be 100% radiographically examined and acceptance criteria shall be as per ASME B16.34.

- c) After final machining, all bevel surfaces shall be inspected by dye penetrant or wet magnetic particle methods. All defects longer than 6.35 mm are rejected, as are defects between 6.35 mm and 1.59mm that are separated by a distance less than 50 times their greatest length. Rejectable defects must be removed. Weld repair of bevel surface is not permitted.

5.1.8 All valves shall be tested in compliance with the requirements of API 6D. During pressure testing, valves shall not have sealant lines and other cavities filled with sealant, grease or other foreign material. The drain, vent and sealant lines shall be

either included in the hydrostatic shell test or tested independently. Test pressure shall be held for at least 30 minutes. No leakage is permissible during hydrostatic testing. The body cavity self-relieving feature meeting the requirements of clause 4.8 of this specification shall also be checked.

5.1.9 A supplementary air seat test as per API 6D (Annex B, Clause B.3.3, Type II) shall be carried out for all valves. A bubble tight seal is required without the use of any sealant. No leakage is allowed. Test pressure shall be held for at least 15 minutes.

5.1.10 Manufacturer who intends bidding, must submit at bid stage, certificate and report for successful fire type-tests for valves in accordance with API-607/ BS EN ISO 10497 / API 6FA, as applicable in Valve Data Sheet.

**Failure to comply with this requirement shall be a cause of rejection of the Bidder's offer.**

5.1.11 Valves shall be subjected to Operational Torque Test as per API 6D (Annex B, Clause B.6) under hydraulic pressure equal to maximum differential pressure corresponding to the valve pressure class rating.

For manual operator of all valves, it shall be established that the force required to operate the valve does not exceed the requirements stated in clause 4.22(c) of this specification.

5.1.12 Power actuated valves shall be tested after assembly of the valve and actuator at the valve Manufacturer's works. At least five Open-Close-Open cycles without internal pressure and five Open-Close-Open cycles with maximum differential pressure shall be performed on the valve actuator assembly. The time for Full Open to Full close shall be recorded during testing. If required, the actuator shall be adjusted to ensure that the opening and closing times are within the limits stated in Actuator Data Sheet issued for the purpose.

Hand operator provided on the actuator shall also be checked after above testing, for satisfactory manual over-ride performance.

These tests shall be conducted on minimum one valve out of a lot of five (5) valves of the same size, rating and the actuator model / type. In case the tests do not meet the requirements, retesting / rejection of the lot shall be decided by Purchaser's Inspector.

5.1.13 Subsequent to successful testing as specified in clause 5.1.11 and 5.1.12 above, one (1) valve out of the total ordered quantity shall be randomly selected by the Purchaser's Representative for cyclic testing as mentioned below :

a) The valve shall be subjected to at least 100 Open-Close-Open cycles with maximum differential pressure corresponding to the valve rating.

b) Subsequent to the above, the valve shall be subjected to hydrostatic test and supplementary air seat test in accordance with clause 5.1.8 and 5.1.9.

-----

In case this valve fails to pass these tests, the valve shall be rejected and two more valves shall be selected randomly and subjected to testing as indicated above. If both valves pass these tests, all valves manufactured for the order (except the valve that failed) shall be deemed acceptable. If either of the two valves fails to pass these tests, all valves shall be rejected or each valve shall be tested at the option of Manufacturer.

Previously carried out test of similar nature shall be considered acceptable if the same has been carried out by Manufacturer in last two years. Valves of two sizes below and two sizes above the size of valve previously tested, and rating similar or one rating lower of valve tested previously, shall be qualified.

- 5.1.14 Checks shall be carried out to demonstrate that the dissimilar metal used in the valves are successfully insulated as per the requirement of clause 4.17 of this specification.
- 5.1.15 When indicated in Valve Data Sheet, valves shall be subjected to anti-static testing as per supplementary test requirement of API 6D (Annex B, Clause B.5).
- 5.2 Purchaser reserves the right to perform stage-wise inspection and witness tests as indicated in clause 5.1 above at Manufacturer's works prior to shipment. Manufacturer shall give reasonable access and facilities required for inspection to the Purchaser's Inspector.

Purchaser reserves the right to require additional testing at any time to confirm or further investigate a suspected fault. The cost incurred shall be to Manufacturer's account.

In no case shall any action of Purchaser or his Inspector relieve the Manufacturer of his responsibility for material, design, quality or operation of valves.

Inspection and tests performed/ witnessed by the Purchaser's Inspector shall in no way relieve the Manufacturer's obligation to perform the required inspection and tests.

## 6.0 EXTENT OF INSPECTION & TESTING

- 6.1 Purchaser's Inspector shall perform inspection and witness tests on all valves or as indicated in the Quality Assurance Plan (QAP) attached with this specification.
- 6.2 The hydrostatic testing and cyclic opening and closing of the valves with the operator shall be witnessed by Purchaser's Inspector.

---

## 7.0 TEST CERTIFICATES

7.1 Manufacturer shall submit the following certificates:

- a) Mill test certificates relevant to the chemical analysis and mechanical properties of the materials used for valve construction as per the relevant standards.
- b) Test certificates of hydrostatic and pneumatic tests complete with records of timing and pressure of each test.
- c) Test reports on radiograph and ultrasonic inspection.
- d) Test report on operation of valves conforming to clause 5.1.11, 5.1.12 and 5.1.13 of this specification.
- e) All other test reports and certificates as required by API 6D and this specification.

The certificates shall be valid only when signed by Purchaser's Inspector. Only those valves which have been certified by Purchaser's Inspector shall be despatched from Manufacturer's works.

## 8.0 PAINTING, MARKING & SHIPMENT

8.1 Valve surface shall be thoroughly cleaned, freed from rust and grease and applied with sufficient coats of corrosion resistant paint. Surface preparation shall be carried out by shot blasting to SP-6 in accordance with "Steel Structures Painting Council – Visual Standard SSPC-VIS-1". For valves to be installed underground, when indicated in Valve Data Sheet, the external surfaces of the buried portion of valves shall be painted with three coats of suitable coal tar epoxy resin with a minimum dry film thickness of 300 microns.

8.2 Manufacturer shall indicate the type of corrosion resistant paint used, in the drawings submitted for approval.

8.3 All valves shall be marked as per API 6D. The units of marking shall be metric except Nominal Diameter which shall be in inches. Marking shall be done by die-stamping on the bonnet or on the housing. However, for buried valves, the marking shall be done on the above ground portion of the stem housing only.

8.4 Valve ends shall be suitably protected to avoid any damage during transit. All threaded and machined surfaces subject to corrosion shall be well protected by a coat of grease or other suitable material. All valves shall be provided with suitable protectors, for flange faces, securely attached to the valves. Bevel ends shall be protected with metallic or high impact plastic bevel protectors.

8.5 All sealant lines and other cavities of the valve shall be filled with sealant before shipment.

8.6 Packaging and shipping instructions shall be as per API 6D.

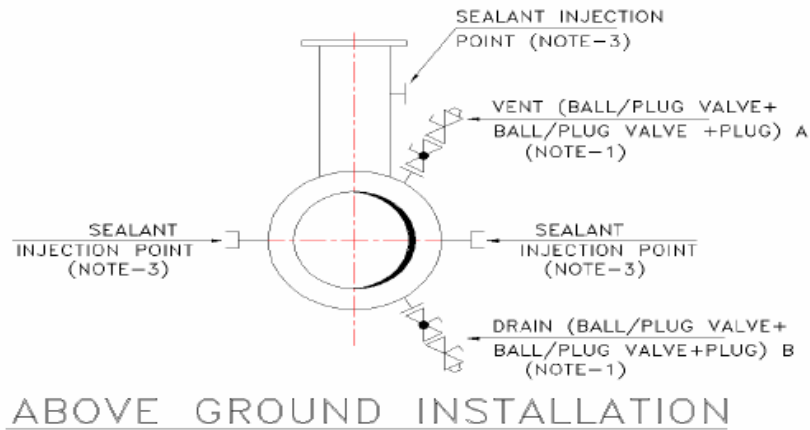

8.7 On packages, following shall be marked legibly with suitable marking ink :

- a) Order Number
- b) Manufacturer's Name
- c) Valve Size and Rating
- d) Tag Number
- e) Serial Number



SIZES OF VENT & DRAIN CONNECTIONS		
NOM. VALVE SIZE	A, DN(mm)	B, DN(mm)
50 TO 150	-	15
200 TO 600	15	25
750 & ABOVE	15	50 (REFER NOTE-2)

**LEGEND:**

-  BALL VALVE
-  PLUG VALVE
-  PLUG

**NOTES:**

- ALL VALVES (BALL OR PLUG) AND PLUGS FOR A AND B SHALL BE APPROVED BY THE PURCHASER.
- VALVES OF SIZE 50mm SHALL BE MANUFACTURED AS PER API-6D.
- SEALANT INJECTION POINTS SHALL BE PROVIDED FOR FULL OPENING VALVES OF NOMINAL VALVE SIZE 200mm (8") & ABOVE AND REDUCED OPENING VALVES OF NOMINAL VALVE SIZE, DN 250mm (10") AND ABOVE ONLY.
- IN BURIED SECTION, ALL VENT & DRAIN CONNECTION SHALL BE OF WELDED CONSTRUCTION.

**FIGURE-1**

## VENT, DRAIN & SEALANT INJECTION DETAILS

### DATA SHEET FOR BALL VALVES

1.0	Valve Manufacturer :		Actuator Manufacturer :
2.0	Valve Size DN (inch) : DN 450 (18")	ANSI Rating : 600#	Design Standard : API 6D
3.0	MECON's Technical Specification No. :	MEC/TS/05/21/002, Rev-1, Ed-1	
4.0	Connecting Pipeline Design Pressure : 92 Kg/cm <sup>2</sup> (g)	Design Temperature, °C : -29°C to +65°C	
5.0	Connecting Pipe Specification :	NA	
5.1	Material		
5.2	Outer Diameter, mm		
5.3	Thickness, mm		
6.0	Valve Construction Design		
6.1	Configuration	: Reduced Bore <input checked="" type="checkbox"/> Full Bore <input type="checkbox"/>	
6.2	End Connections	: Flanged as per ASME B16.5 <input checked="" type="checkbox"/> But Welded as per ASME B16.25 <input type="checkbox"/>	
6.3	Flanges (wherever applicable)	: a) RF <input checked="" type="checkbox"/> RT <input type="checkbox"/>	NA <input type="checkbox"/>
		: b) Serrated <input type="checkbox"/> Smooth (125 to 200 micrometers AARH) <input checked="" type="checkbox"/>	NA <input type="checkbox"/>
6.4	Ball Mounting	: Trunnion Mounted	
6.5	Valve body type	: Fully Welded <input type="checkbox"/> Two/Three Piece Bolted <input type="checkbox"/>	Either <input checked="" type="checkbox"/>
6.6	500 mm pup piece (integrally welded to the valve on each side) :	Yes <input type="checkbox"/> No <input checked="" type="checkbox"/>	No <input type="checkbox"/>

(Material, Outer Diameter and Thickness of pup piece to be same as that of the connecting pipe mentioned above)

7.0 Valve Material Specification

Part	Specified Material	Material Offered (Equivalent or superior)
7.1 Body	A 216 Gr. WCB / A 234 Gr. WPB	
7.2 Ball	(A 216 Gr.WCB/A 234 Gr.WPB) +75 µENP coating/ AISI410	
7.3 Body Seat Rings (No Casting)	AISI 4140 + 75 micron ENP coating/AISI 410	
7.4 Seat Seal	VITON/DEVLON	
7.5 Stem (No casting)	AISI 4140 + 75 micron ENP coating/AISI 410	
7.6 Stem Seals	VITON/PTFE	
7.7 Trunnion	A 216 Gr. WCB/ A 105	
7.8 Stud Bolts/ Nuts	ASTM A 193 Gr. B7/ A194 Gr. 2H	

8.0 Corrosion Allowance : 1.5 mm Service : Natural Gas

9.0 Location : Above Ground  Buried

10.0 Stem Extension Requirement : Yes  No

11.0 Gear Operator Requirement : Yes  No

12.0 Actuator Requirement : Yes  No  REMOTE OPERATED AV as per TS No. MEC/ TS / 05 / E5 / 002A With AUTO CLOSURE facility

13.0 Fire Resistant Design Requirement : Type test as per API 6FA/API607

14.0 Valve Testing Requirement

	Test Pressure (min.), kg/cm <sup>2</sup> (g)	Minimum Duration, minutes
14.1 Hydrostatic Test		
	Body	157
	Seat	114
14.2 Air Test	5.6-7	As per API 6D

15.0 Anti-Static Testing Requirement : As per Standard API 6D (Latest Ed.)

16.0 Valve Painting Specification

16.1 Surface preparation by Short Blasting as per grade SA 2 1/2, Swedish Standard SIS-055 909.

16.2 For above ground installation-Three coats of corrosion resistant paint shall be applied with minimum thickness of 300 micron ( Permissible thickness in each coat shall be within 80 to 120 micron).

Colour of paint shade shall be RAL-7038, however any change in colour shall be finalized during drawing approval stage.

17.0 Lock Open/ Lock Close/Normally Close Requirement : NA

All documents shall be in English Language only.

## **SECTION-VII**

### **PRICE SCHEDULE / SCHEDULE OF RATES**

## SCHEDULE OF RATES (SOR)

**SUB:** PROCUREMENT OF BALL VALVE FOR BI- DIRECTIONAL FLOW ARRANGEMENT IN COMPRESSOR STATION, BAIHATA.

**Tender No.:** IGGL/GHY/C&P/PROJ/BALL-VALVE/04-26

**Name of Bidder:** M/s \_\_\_\_\_

Items Sl. No.	Items Description	Qty.	UOM	Rate (In Rs.)	Amount (In Rs.)
1.	<b>BALL VALVE:</b> Type: HOV 18" (RB,FE), Carbon Steel Ball Valves, #600, Design Standard: API-6D, as per technical specifications and data sheets mentioned in the tender.	04	Nos.		
<b>Total Amount including P&amp;F, Freight, Insurance &amp; TPI (Rs.)</b>					
<b>GST@ 18%:</b>					
<b>Total amount including GST:</b>					

**NOTE TO BIDDERS:**

1. Quoted rates should be excluding of GST.
2. Bidders have to mandatorily quote for all the quantities mentioned in the SOR.
3. **PRICE / RATES TO BE ENTERED ONLY IN THE PRICED BID FORMAT/BOQ AVAILABLE IN THE E-TENDERING PORTAL.**

---

## **SECTION-VIII**

## **ATTACHMENTS**

[Not Applicable for this tender]